

# Wireless Network and Mobility

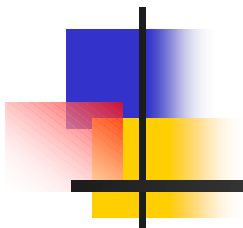

**Dept. of Computer Science, University of Rochester**



# Wireless Networks and Mobility

---

- Wireless networking in the data link layer
  - Short range: IEEE 802.15 Bluetooth
  - Medium range: IEEE 802.11 wireless LAN (WiFi)
  - Long range: Cellular Internet access and long range WiFi
- Mobility in the network layer
  - Infrastructured wireless mobile networks
  - Ad hoc wireless mobile networks

# Media Access Control for Wireless Networks

- Collision if 2 or more nodes transmit at same time
- Efficiency goal of media access control:
  - get all the bandwidth if you're the only one transmitting
  - share the bandwidth fairly if multiple nodes transmit
- CSMA/CD (what is CSMA/CD??)
- **Hidden terminal problem**
  - the sender doesn't know if a transmission is successful
  - collision detection doesn't work

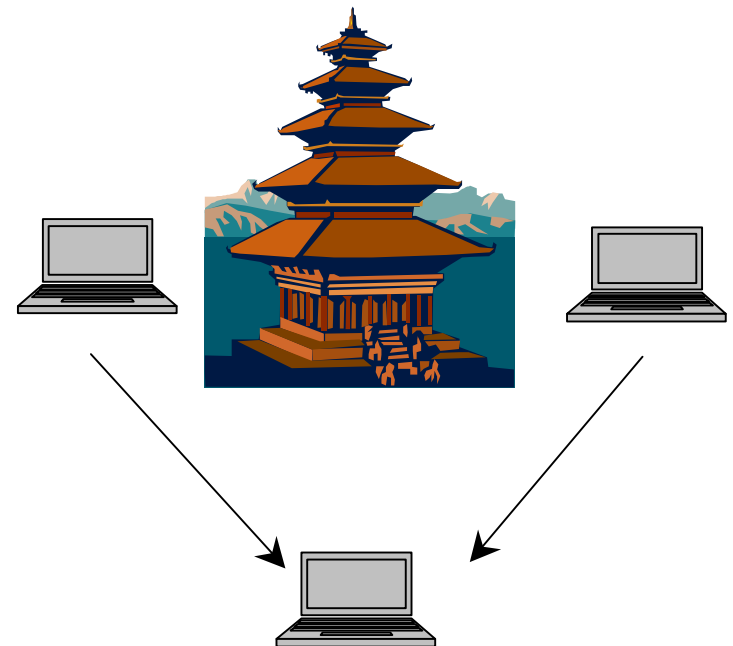

# IEEE 802.11 MAC Protocol: CSMA/CA

## 802.11 CSMA sender

- if sense channel idle for **DIFS** sec; then transmit entire frame (no collision detection)
- if sense channel busy; then backoff

## 802.11 CSMA receiver

- if received OK; return ACK after **SIFS** (ACK is needed due to hidden terminal problem)

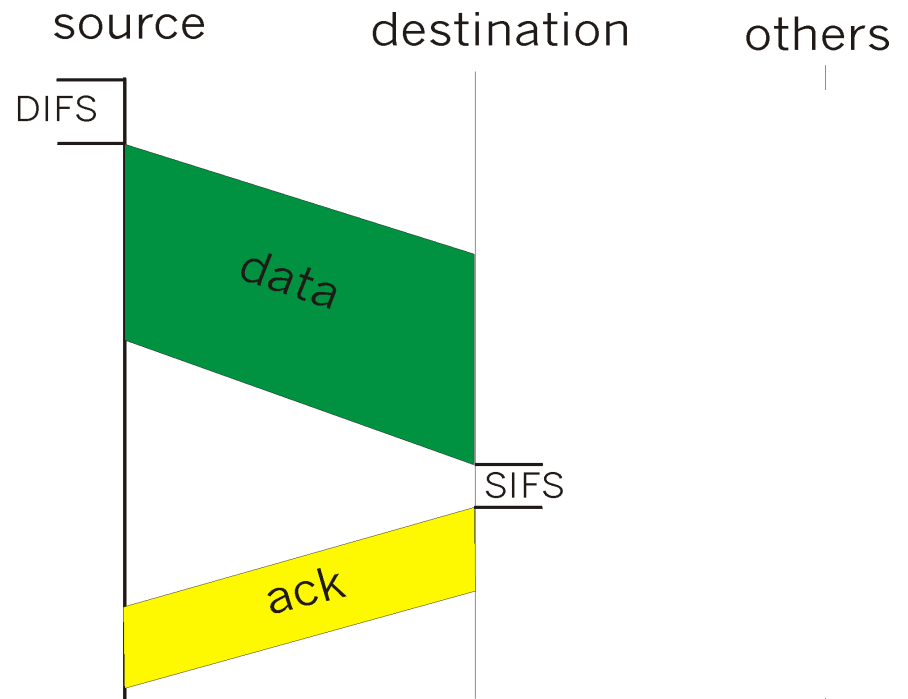

# Better Collision Avoidance through RTS-CTS Exchange

- sender transmits short RTS (request to send) packet: indicates duration of transmission
- receiver replies with short CTS (clear to send) packet
  - notifying (possibly hidden) nodes
- nodes hearing either RTS or CTS will not transmit for specified duration: NAV
- Collision is unlikely because RTS/CTS are short.

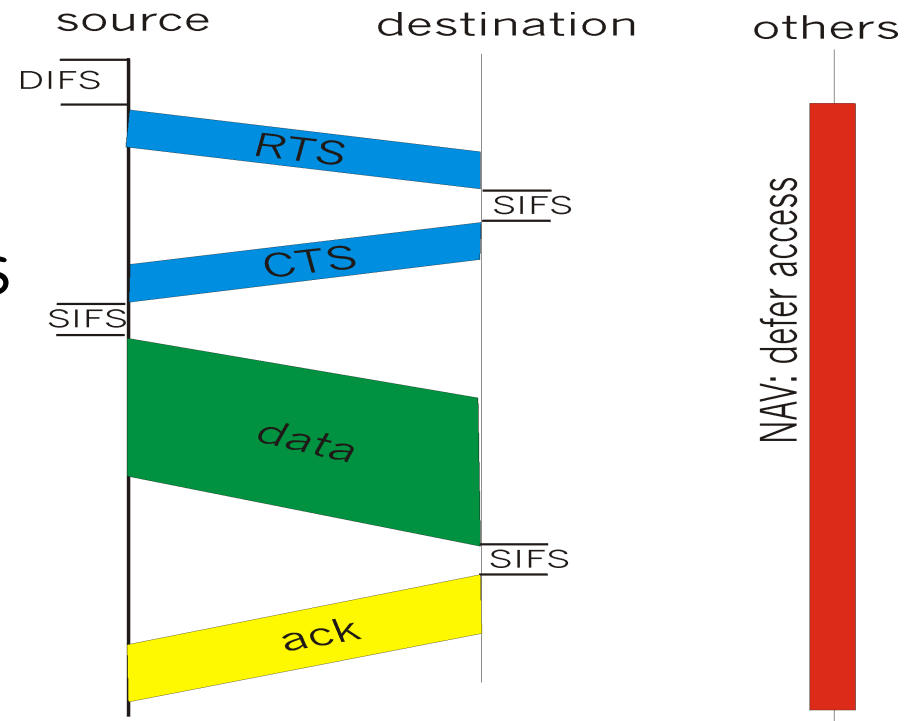

IEEE 802.11 MAC Protocol: **CSMA/CA**



# Wireless Networks and Mobility

---

- Wireless networking in the data link layer
  - Short range: IEEE 802.15 Bluetooth
  - Medium range: IEEE 802.11 wireless LAN (WiFi)
  - Long range: Cellular Internet access and long range WiFi
- Mobility in the network layer
  - Infrastructured wireless mobile networks
  - Ad hoc wireless mobile networks



# Mobility issues

---

- The desire for mobility abounds
  - Phone number portability
  - Cell phone handoffs among towers
  - Are there Internet handoffs among access points?
- “Any problem in computer science can be solved with another layer of indirection.”  
— David Wheeler, chief programmer for the EDSAC project in the early 1950s.
- Locations and End-point Identifiers are separate concepts
- But not in TCP or UDP
- Mobility offers opportunities for interception and redirection, so there are security considerations

# Mobility: Base Station Model

- Wireless host communicates with a **base station** or **access point (AP)**.
- **Basic Service Set (BSS)** contains:
  - a base station;
  - wireless hosts reachable from the base station.
- Base stations are connected to each other and wide-area network through wired links.

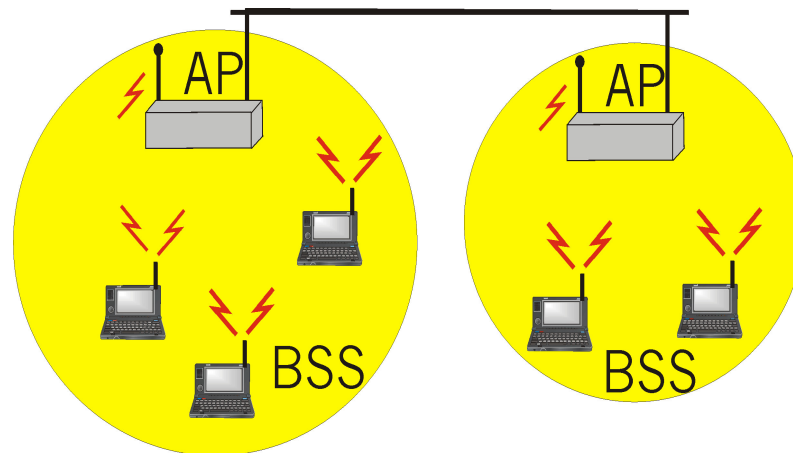

# Mobility: Ad Hoc Network Model

- No base stations or access points
- Wireless hosts communicate with each other directly
  - to get packet from wireless host A to B may need to route through wireless hosts X, Y, Z
- Compared with based station model
  - more flexible
  - require complex support
- Applications:
  - "laptop" meeting in conference room, car
  - interconnection of "personal" devices
  - battlefield

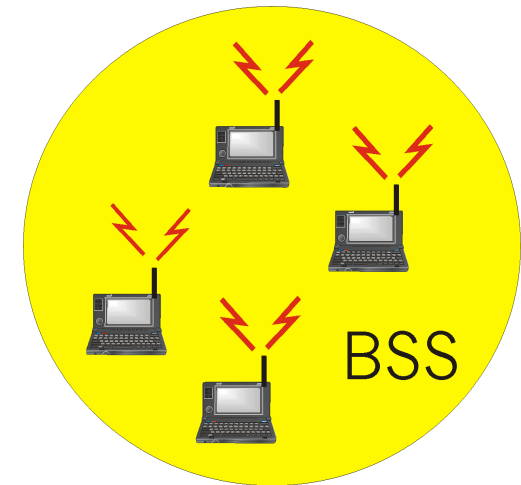

# Addressing: when mobile is at home

**home network:** permanent "home" of mobile  
e.g., 128.119.40/24

**home agent:** entity that will perform mobility functions on behalf of mobile, when mobile is remote

**permanent address:** address in home network, can always be used to reach mobile  
e.g., 128.119.40.186

wide area network

**correspondent:** wants to communicate with mobile

# Addressing: when mobile is moving around

**Permanent address:** remains constant (e.g., 128.119.40.186)

**visited network:** network in which mobile currently resides (e.g., 79.129.13/24)

**Care-of-address:** address in visited network. (e.g., 79.129.13.2)

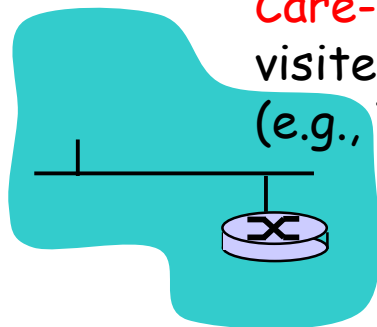

wide area network

correspondent

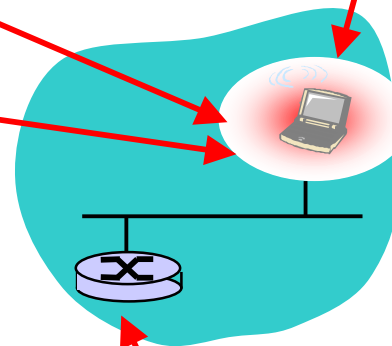

**foreign agent:** entity in visited network that performs mobility functions on behalf of mobile.

# Mobile Registration

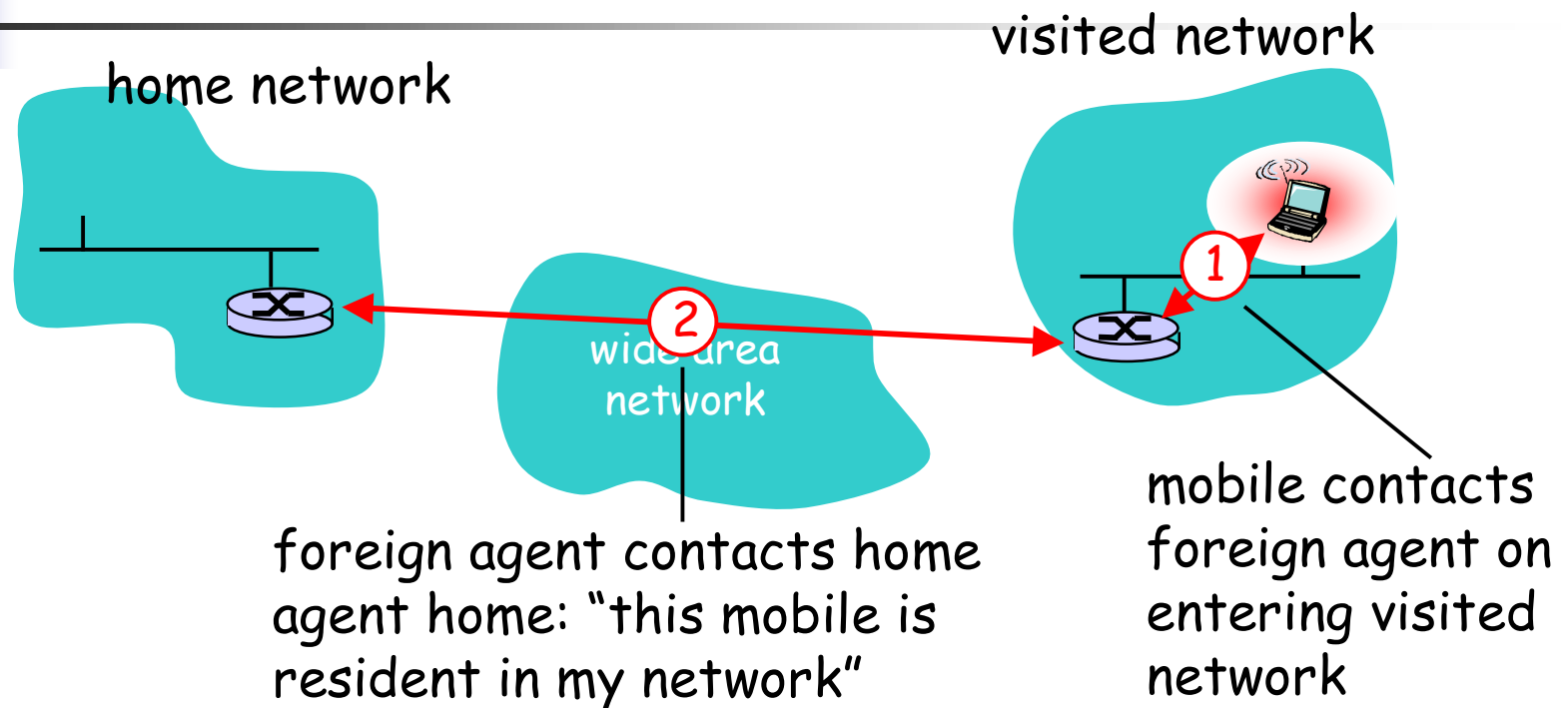

End result:

- Foreign agent knows about mobile
- Home agent knows location of mobile



# Principles of Mobile Routing

---

- **Indirect routing**
  - communication from correspondent to mobile goes through home agent, then forwarded to remote
- **Direct routing**
  - correspondent gets foreign address of mobile, sends directly to mobile

# Mobility via Indirect Routing

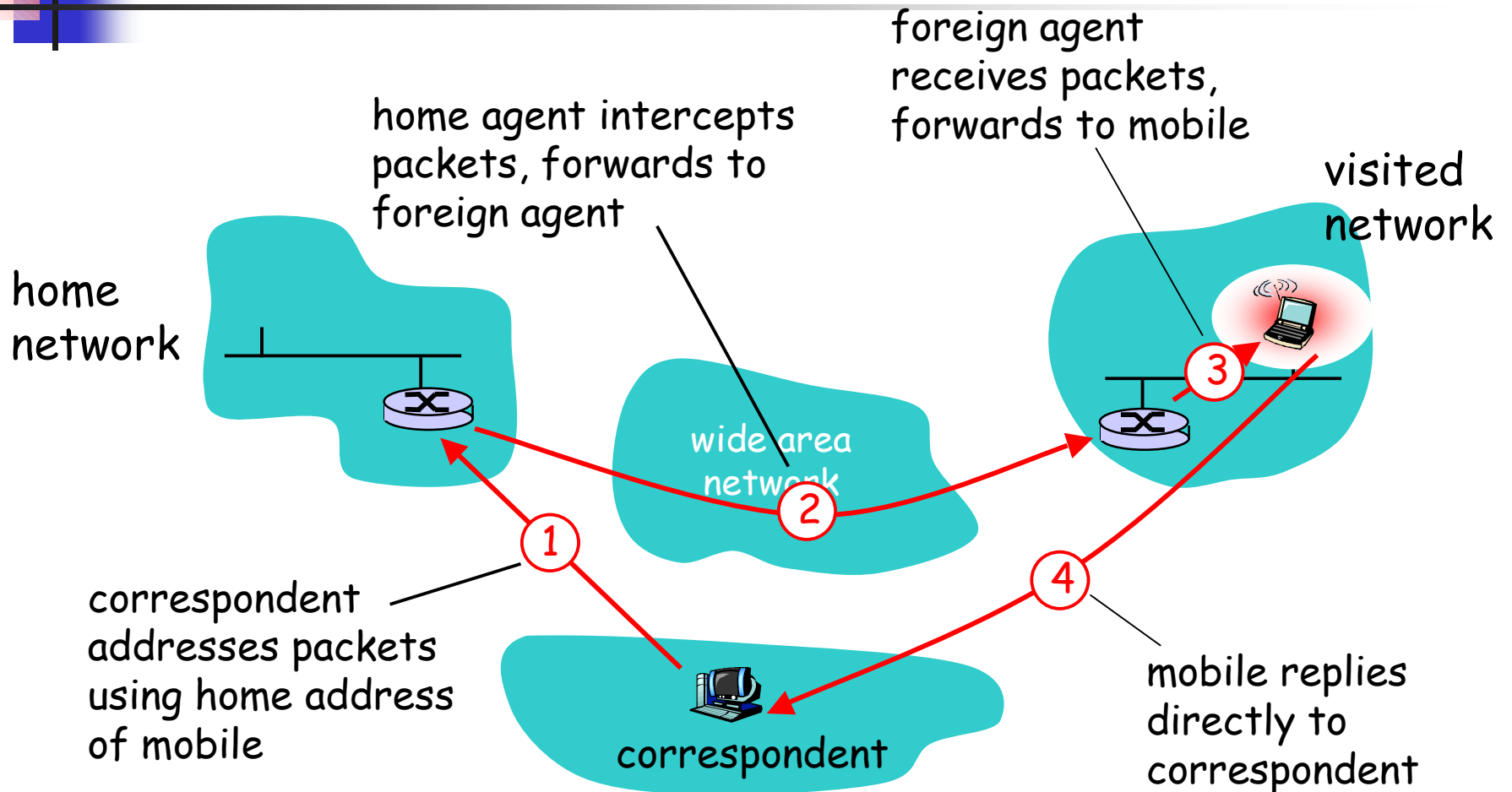

# Forwarding Packets to Remote Mobile: Encapsulation

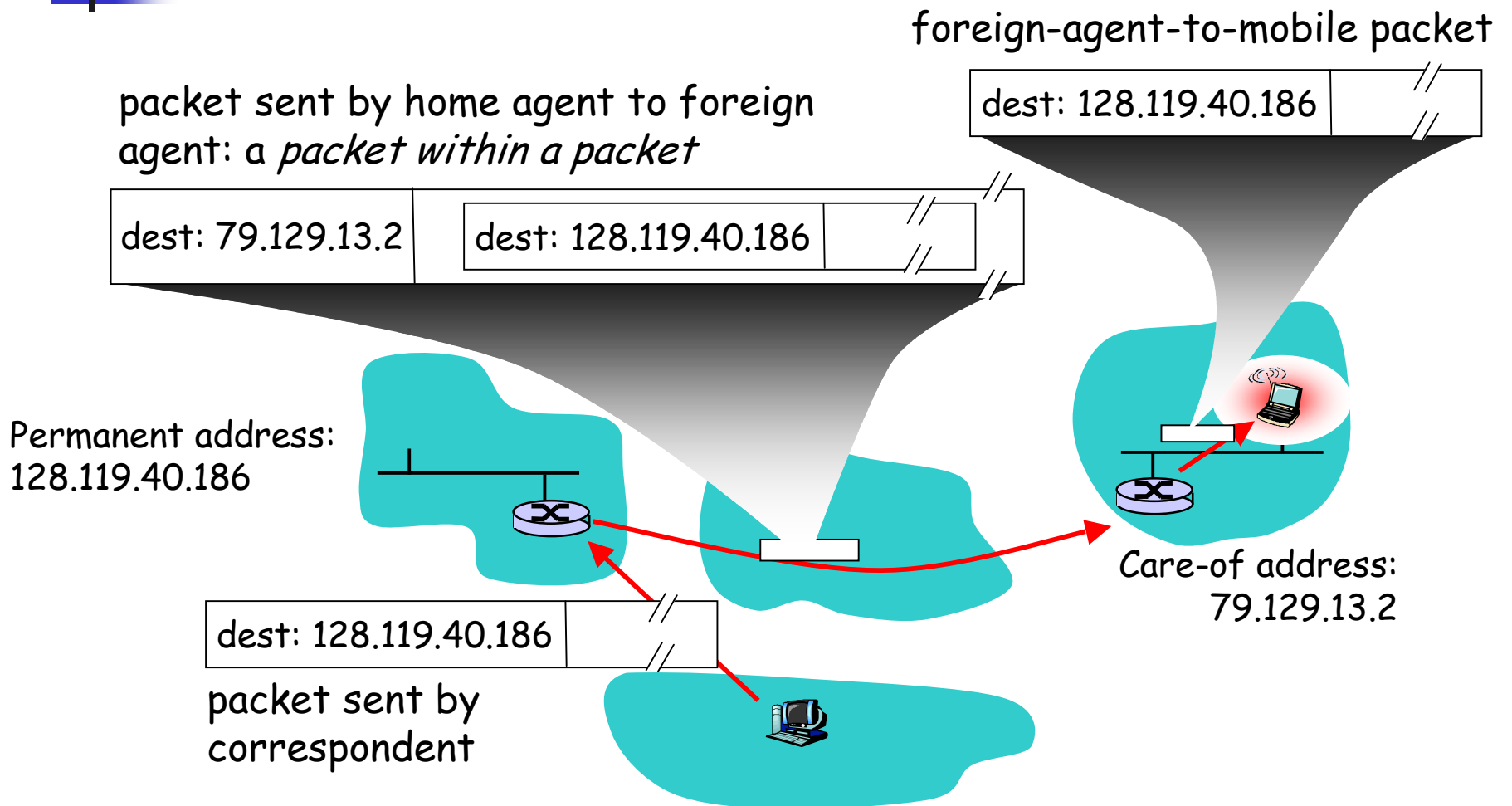

# Indirect Routing: Discussions

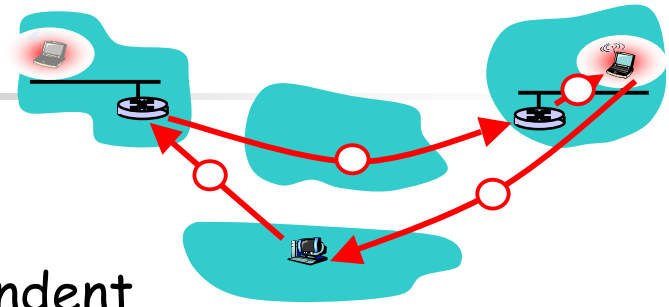

- Mobile uses two addresses:
    - **permanent address**: used by correspondent
    - **care-of-address**: used by home agent to forward packets to mobile
  - **triangle routing**: corres.-home-network-mobile
  - suppose mobile user moves to another network
    - registers with new foreign agent
    - new foreign agent registers with home agent
    - home agent updates care-of-address for mobile
    - packets continue to be forwarded to mobile (but with new care-of-address)
- ⇒ Mobility, changing foreign networks transparent

# Mobility via Direct Routing

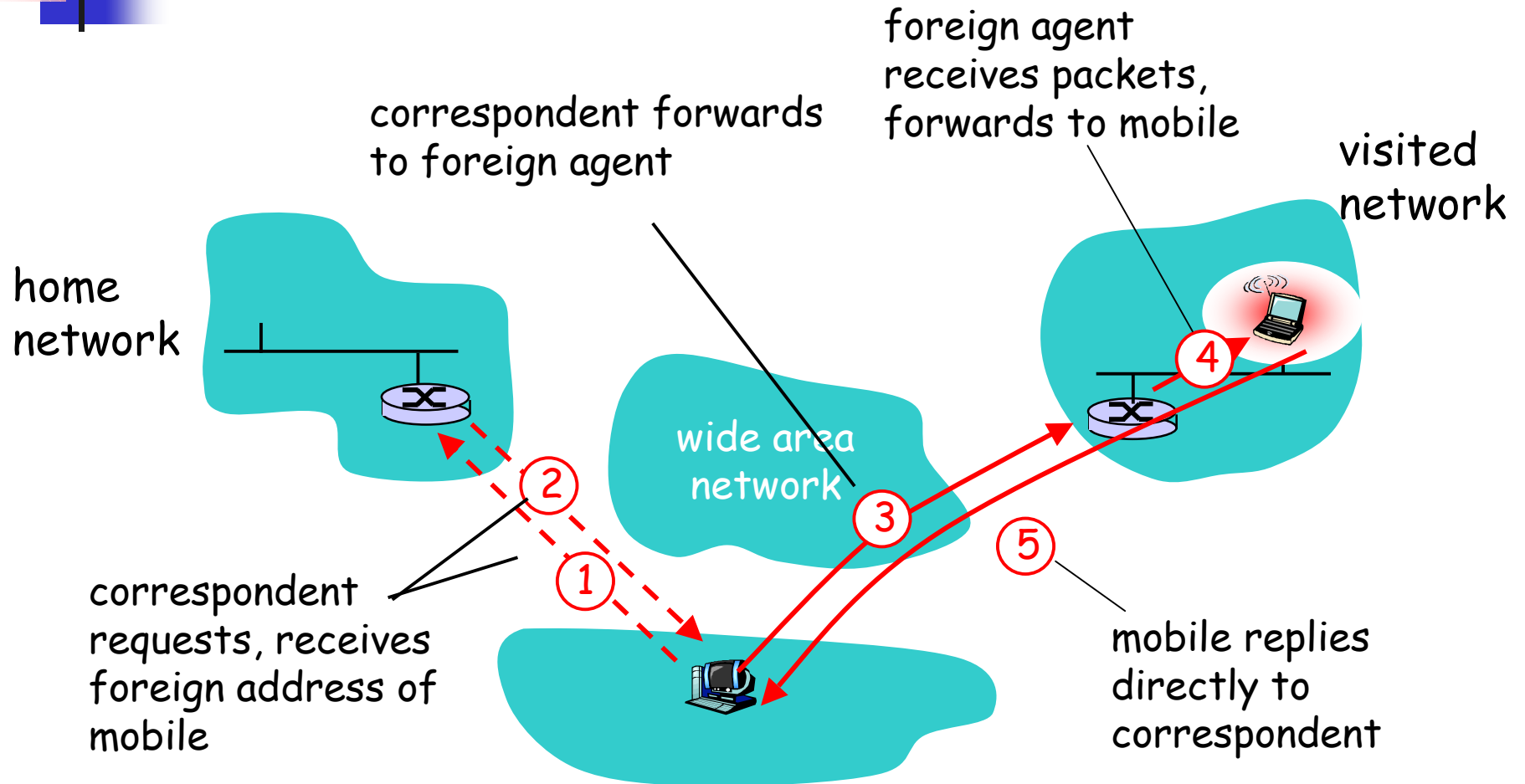

# Indirect Routing vs. Direct Routing

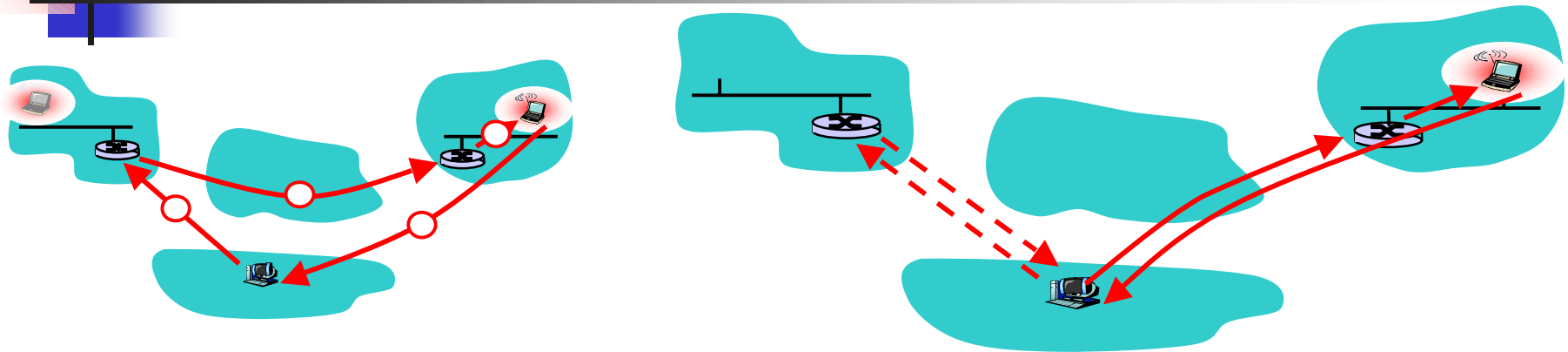

- Efficiency

- Indirect routing is inefficient, especially when correspondent, mobile are near but home is far

- Transparency

- Indirect routing is transparent to correspondent, smoother handoff when moving between networks



# Mobile IP

---

- Network-layer mobility protocol interoperable with IP [C. Perkins, 2002]
- Has many features we've seen:
  - home agents, foreign agents, foreign-agent registration, care-of-addresses, encapsulation (packet-within-a-packet)
  - use indirect routing



# Mobile Ad Hoc Networks

---

- Open research area
- Addressing
  - Requirements for addressing in MANET?
- Routing
  - Any idea about finding good routes for MANET?



# Disclaimer

---

- Parts of the lecture slides contain original work of James Kurose, Larry Peterson, and Keith Ross. The slides are intended for the sole purpose of instruction of computer networks at the University of Rochester. All copyrighted materials belong to their original owner(s).