

von der Heydt R, Friedman HS, Zhou H (2003) Searching for the neural mechanisms of color filling-in. In: Filling-in: From Perceptual Completion to Cortical Reorganization (Pessoa L, De Weerd P, eds), pp 106-127. Oxford: Oxford University Press.

Searching For The Neural Mechanism Of Color Filling-In

Rüdiger von der Heydt, Howard S. Friedman and Hong Zhou

Krieger Mind/Brain Institute and Department of Neuroscience, Johns Hopkins University

Corresponding Author:

Rüdiger von der Heydt
Krieger Mind/Brain Institute
Johns Hopkins University
3400 N. Charles St.
Baltimore, MD 21218 USA
Phone 410-516-6416
Fax 410-516-8648
E-mail: von.der.heydt@jhu.edu

Introduction

In this chapter we will discuss a perceptual phenomenon in which visual stimuli seem to assume the color and brightness of the surrounding region and thereby vanish from perception. We will first review the basic findings and theories in order to clarify the origin of the ideas that guided recent neurophysiological studies. We will then review those recent studies which tried to solve the puzzle of filling-in by means of single-cell recording in monkeys.

There are four types of conditions under which color filling-in has been observed. One example is the filling-in of the blind spot in monocular viewing. If seen against a surface of uniform color, the part of the visual field corresponding to the blind spot appears in the color of that surface although obviously no color signals are generated at the blind spot. Second, patients with a scotoma (which may be caused by lesion of retina or visual pathways) report filling-in of the region corresponding to the scotoma. The third condition is artificial stabilization of the retinal image. Image stabilization can be achieved, for example, by mounting a small projector with a suction cap on the eye (Iarbus, 1957; Gerrits et al., 1966; Yarbus, 1967). The stabilized stimulus appears to fade gradually and to assume the color of the surrounding region. The fourth contingency is known as Troxler's effect. Under conditions of steady fixation, visual scenes gradually lose contrast until some objects disappear from perception (Troxler, 1804, cited in Fiorentini et al., 1989). Disappearance, however, generally means filling-in since the final appearance of the stimulus depends on the color of the background (Spillmann, Neumeier, Hunzelmann, 1984; Livingstone & Hubel, 1987). Thus, it is clear that this phenomenon cannot be fully explained by local processes such as adaptation, but also involves filling-in. The events observed under steady fixation (Zhang & von der Heydt, 1995; Friedman et al., 1999) are similar to those that occur under artificial image stabilization (Krauskopf, 1963; Gerrits et al., 1966; Yarbus, 1967; Ditchburn, 1973), but are generally more variable, presumably because of the irregularity of residual eye movements.

Thus, perceptual filling-in of color can occur in parts of the visual field for which no retinal signals exist (across the blind spot and other scotomas), but it can also occur over intact retinal regions under conditions of image stabilization. In the former case, filling-in occurs immediately or very rapidly, whereas in the latter case, it takes appreciable time, usually several seconds.

It has been hypothesized that all of the above observations share a common neural mechanism that is basic to the perception of color and brightness of surface in general (Walls, 1954; Gerrits & Vendrik, 1970; Cohen & Grossberg, 1984; Paradiso & Nakayama, 1991; see also Pessoa et al., 1998). Specific theories of filling-in postulate that perception is based on an image representation held in a 2-dimensional array of neurons, in which color signals spread in all directions except across borders formed by contour activity (Gerrits & Vendrik, 1970; Cohen & Grossberg, 1984; Arrington, 1994). The process is thought to be analogous to physical diffusion, with contours acting as diffusion barriers for the color and brightness signals. As a result, these signals tend to fill the regions between the contours evenly like water filling in the space between dikes. Since this theory assumes pointwise representation of visual information (the activity of each element of the array represents either color or contour strength for one location in the visual field) we will call it the isomorphic filling-in theory. Although the above studies differ widely in various aspects, we think it is fair to regard them as exemplifications of the same theory.

The isomorphic filling-in theory originated with the observations made in patients with visual scotomas and the striking phenomena discovered in retinal image stabilization (Riggs et al., 1953; Krauskopf, 1963; Gerrits et al., 1966; Yarbus, 1967). A detailed neural theory emerged when Gerrits and colleagues compared these observations with single cell recordings from the cat optic tract, LGN, and striate cortex published by other authors at the time. It may be worthwhile to recapitulate here the basic arguments, as summarized in Gerrits & Vendrik (1970).

The neural representation of a stimulus, such as a bright uniform disk, was found to differ from the perception of that stimulus in two ways: First, the neurons generally responded to the onset of the stimulus with a brief transient elevation of firing rate, whereas perception of brightness and color is constant over time. Second, the spatial distribution of neural activity was uneven, high for the border regions, low for the inner of the disk, whereas the disk appears uniform in perception. In addition, with image stabilization, the color of the disk was perceived for several seconds before it appeared to be filled in, but the transient elevation of firing rate lasted less than 0.1 seconds. Therefore, Gerrits et al. concluded that the moment of perceptual filling-in was not related to the decay of neural activity at those levels. Instead, they postulated a neural representation, called the "higher center", in which the short afferent bursts are integrated and stored with a relatively long time constant. The additivity of integration at this level was demonstrated by applying luminance increments and decrements to a stabilized stimulus. The role of the contrast borders in forming diffusion barriers was shown by demonstrating that a large bright disk that had faded would reappear completely upon small displacements, even though the displacements only modulated the illumination of receptors near the borders, but not receptors near the center of the disk. When a stabilized bright bar that had faded was subsequently moved along its long axis, it created the perception of brightness spreading from behind the leading edge, and darkness spreading from behind the trailing edge, while most of the lateral borders remained invisible (Yarbus, 1967, Fig. 46; Gerrits & Vendrik, 1970, Fig. 3). Thus, it seemed as if brightness and darkness signals were generated at the moving contrast borders, and as if the spreading of these signals was limited only by the moving borders, whereas the stationary borders were permeable.

The observation of delayed filling-in is an important point. It has been argued that the observation of perceived uniformity does not necessarily require the assumption of a filling-in process. Spatial filling-in might simply reflect the fact that different physical patterns of luminance distribution can be physiologically equivalent (Ratliff, 1978; see Fiorentini et al., 1989, for further references). For example, Cornsweet's luminance pattern is perceived as a uniform disk because both produce essentially the same patterns of neural activity. The same explanation would hold for filling-in of blind spot and scotomas. However, the experience of a color change occurring during physically constant stimulation suggests that filling-in is a physiological process and not just a convention of coding.

In Figs. 1A--C we have summarized the arguments described above in cartoon form. It appears natural to assume that perception of the color of a surface is given by the activity of the cells whose receptive fields point at the surface (Fig. 1A). However, this is clearly not the case as shown by a variety of filling-in phenomena (e.g., color is perceived at the blind spot in the absence of receptive fields, yellow and blue are perceived in the center of the fovea which lacks S-cones). According to the isomorphic filling-in theory (Fig. 1B), color is also represented by the activity of cells whose receptive fields point at the surface, but it is assumed that these cells receive additional activation through horizontal connections which keeps their activity level high

despite mechanisms of lateral inhibition which tend to suppress surface activity, and despite the transient nature of the afferent signals. Dashed arrows in Fig. 1B indicate the unreliable afferent signals. The lateral activation comes from receptive fields at contrast borders. These signals are strong, because receptive fields are exposed to contrast, and reliable, because the border produces continuous light modulation even during fixation due to small residual eye movements. The lateral connections also activate the cells representing the blind spot region which have receptive fields only in one eye, keeping up their activity when that eye is occluded. Figure 1C illustrates an alternative hypothesis to explain filling-in. This hypothesis assumes that image information is transformed at the cortical level into an oriented feature representation from which form and color are derived at a subsequent stage. This could be a stage of preliminary grouping based on rather mechanistic bottom-up processing, or an "object file" generated by means of attentional feature binding. In this model, color is not represented in an isomorphic manner, but as an attribute of an object or proto-object (tentative association of features by low-level mechanisms). This theory also explains the perceptual observations, but in a completely different way: Blind spot and scotomas generate no border signals because there are no cortical cells whose receptive fields straddle their borders. Therefore, they do not give rise to object representations. However, if a large disk is presented over a scotoma, it generates the proper contrast border signals from which the shape and color of the disk are derived. Retinal stabilization of a stimulus causes adaptation of border signals, leading to its perceptual disappearance. What is perceived, then, is the color of the "underlying" object whose representation is based on signals of more distant borders which are not stabilized. Small eye movements will revive the adapted border signals, regenerating the object representation. Since this theory postulates a change at a symbolic level of representation (e.g., cessation of activity in a group of cells representing an object) we call it the symbolic filling-in theory.

Limitation of space precludes the discussion of all the phenomena of filling-in that have been reported, but the arguments sketched so far may convince the reader that virtually every finding can be explained easily and parsimoniously in the isomorphic and the symbolic theory. Despite many attempts to decide the case by psychophysical experiments the mechanisms of color filling-in are still unknown.

Literature review

We shall review recent attempts to clarify the basis of color filling-in by means of single-cell recording. The earlier attempts in relating perception to neural activity by Gerrits and co-workers, as reviewed above, are unsatisfactory in two respects. First, human perception was compared with neurophysiological data from cats, whose visual system differs markedly from ours, particularly in regard to color vision. For better comparison with human perception we need to study the neural activity in a primate species. Second, the arguments were indirect, via the spatio-temporal characteristics of neural processing (as measured, for example, with flashing spots of light). Much more convincing evidence could be obtained by recording the activity of neurons directly under the conditions in which filling-in occurs.

Immediate filling-in

Even though the visual system of macaque monkeys is known to be similar to that of humans we need proof that monkeys also experience color filling-in. Komatsu and colleagues have recently demonstrated this for filling-in through the blind spot and through retinal scotomas (Komatsu & Murakami, 1994; Murakami et al., 1997). Monkeys were taught to discriminate between disks and rings. When a ring was then presented over the blind spot so that its inner contour fell on the blind region the animals responded as if a disk were presented.

Komatsu and colleagues also analyzed the activity of cells of the blind spot representation in striate cortex (area V1) and found cells, in layers 4--6, that responded to large stimuli covering the blind spot (Komatsu et al., 2000). Most of these cells had particularly large classical receptive fields with a residual field in the eye of the blind spot and therefore responded to small stimuli near the blind spot (that is, stimuli which do not produce perceptual filling-in). However, some cells had only small classical receptive fields in the seeing eye inside the region corresponding to the blind-spot. These cells did not respond to small stimuli near the blind spot, but responded if a large stimulus covered it, which is exactly the condition that produces perceptual filling-in. Thus, there seem to be connections that can transmit color and brightness information into the blind region. The exact nature of this pathway is not yet clear; convergence of afferent signals, horizontal intracortical connections (as suggested in Fig. 1B), or feedback projections from extrastriate areas could all play a role.

Delayed filling-in

The experiments discussed so far dealt with filling-in of scotomas and did not examine the role of contours as diffusion barriers for color signals, which is an important feature of the isomorphic filling-in theory. Only after the cessation of contour activity under stabilized vision can color signals spread across the contours and fill the enclosed area. Whereas the spread of signals must be relatively fast because even large stimuli appear uniform shortly after stimulus onset (Paradiso & Nakayama, 1991; Arrington, 1994), the break down of the dikes of contour activity under stabilization apparently takes some time (Gerrits & Vendrik, 1970). Thus, the critical question is: does the neural activity change at the time of delayed filling-in?

To answer that question, we first need to know if monkeys perceive color filling-in under steady fixation similarly as humans do. Zhang (1995) and Friedman et al. (1999) developed a method for measuring perceptual filling-in that can be applied with humans as well as monkeys. They used a disk-ring stimulus in which the disk-ring border was of moderate contrast and blurred, whereas the outer border of the ring was of high contrast and sharp (Fig. 2, right). The result was that the disk tended to disappear after a few seconds under steady fixation, whereas the outer contour of the ring was perceived much longer, and the area of the disk appeared to be filled in with the color of the ring (Krauskopf, 1967). We used the complementary colors red and green for disk and ring, and assigned these colors alternatingly to disk and ring so as to keep local color adaptation constant over the test sessions (complementary colors add up to neutral). Color saturation was set at 30% of the maximum that was attainable on a CRT color monitor. Despite being desaturated, the hues could be clearly perceived. The subjects had to fixate their gaze on a fixation target 2.5° from the center of the disk. Fixation was controlled by having subjects respond to an orientation change of a small fixation target which occurred randomly in some trials and could be detected only in foveal vision. The monkeys were rewarded if they

responded within 0.4 s after the target change. If they missed this interval they were not rewarded and punished by delaying the beginning of the next trial. Eye position was monitored with an infrared pupil tracking system and larger eye movements were also punished by reward withholding and delay.

Monkeys cannot be instructed to respond to a visual illusion. However, they can be trained to signal reliably a physical color change in the stimulus that resembles the illusion of filling-in. We expected that, when a monkey was well trained, it would then respond also in randomly inserted test trials in which there was no physical change, but an illusory change of color. This strategy works only if the subject confuses the illusory change with a physical change. Thus, if a monkey does not respond in those test trials, it might be either because the animal does not perceive filling-in, or because the physical changes do not mimic the perceptual filling-in well enough. However, if an animal responds consistently in the absence of a physical change under certain conditions, this would be strong evidence that it experiences illusory filling-in under these conditions.

Using the method described above we have compared filling-in in humans and monkeys (Friedman et al., 1999). Two classes of stimuli were randomly intermixed, control stimuli in which the physical color of the disk was gradually changed to that of the ring, and test stimuli in which the physical colors remained constant (Fig. 3). The transition time for the control stimuli varied from trial to trial. The human subjects were instructed to respond when the disk merged with the ring forming a large uniform disk. The monkeys were first trained for several months with only control trials in which they were rewarded if they indicated the moment when the disk merged with the ring. In the beginning, a fast transition of color occurred at a randomized time in each trial. Later, the time constant of color change was also randomized and gradually extended, so that a response was required as early as 1.5 s after stimulus onset in some trials, and as late as 7 s in others. The animals were then tested with a mixture of control trials (92%) and test trials (8%). In test trials they were rewarded randomly. To see if the subjects performed the task as intended, the disk was presented in four different modes: static or moving (circular oscillation), and with sharp or blurred border. Since sharp borders and movement are both known to reduce the probability of perceiving filling-in, we expected that the frequency of responses would be affected accordingly.

The results of this experiment showed that for monkeys as well as human subjects the blurred disks were more likely to produce a filling-in response than sharp disks, and static disks more likely than moving disks. Fig. 4 shows the probability of filling-in responses for the static-blurred condition as a function of time after stimulus onset. Filling-in responses began to occur after 3--4 s, and, by the end of 6 s, the probability reached 22--80%, depending on the subject. While the rate of the increase varied between subjects, the time course was remarkably similar between humans and monkeys. It can be seen that responses before 3 s were extremely rare. This is in contrast to the control trials (92% of all trials) in which 25% of the responses occurred before 3 s, indicating that the monkeys responded when they perceived the change, and not when they expected it. Thus, the dependence on the stimulus condition and the distribution of response times are strong evidence that monkeys perceive color filling-in under steady fixation just as humans do.

Some basic facts about cortical coding of colored figures

Before we discuss the neurophysiological processes during delayed filling-in, we have to clarify a few points about the cortical representation of colored figures. First of all, Gerrits' assumption that uniform illumination of receptive fields produces only weak excitation of cells in the visual pathways does not hold for chromatic stimuli in the monkey. The most common type of cell in the monkey LGN, the color-opponent center-surround cell (type I, Wiesel & Hubel, 1966) responds best to large uniform stimuli of the preferred color. These cells show low-pass spatial frequency tuning for chromatic gratings, but band-pass tuning for luminance gratings (De Valois & Pease, 1971). It is only at the cortical level that color surface responses are reduced (Hubel & Wiesel, 1968; Thorell et al., 1984). Recordings from alert behaving monkeys (von der Heydt et al., 1996; Zhou et al., 2002) show that, in layers 2--3 of V1, 85% of cells respond almost exclusively to contrast borders ("edge cells": surface response < 25% of edge response), while only 15% can be activated by larger uniform stimuli centered on the receptive field ("surface cells").¹ The proportions in area V2 are quite similar. Thus, although the relative amount of surface activity is greatly reduced in the cortex compared to the LGN, surface signals still exist.

The second point is that, contrary to common belief, color selectivity is as common among orientation selective cells as it is among unoriented cells (Michael, 1978a,b; Thorell et al., 1984; Levitt et al., 1994; Leventhal et al., 1995; von der Heydt et al. 1996). Since the vast majority of cells in the superficial layers of V1 and in V2 are orientation selective, this means that far more color information is present in oriented than unoriented signals (Zhou et al., 2002). Furthermore, many of these cells provide not only color information, but are also selective for contrast-polarity at the border. For example, a cell may respond to a gray-red border of certain orientation, but not to a red-gray border of the same orientation.

Thus, the physiological facts, as presently known, are compatible with both the isomorphic and the symbolic theory (Figs. 1B and 1C). It is possible that afferent surface signals are suppressed at the cortical level, as Gerrits and Vendrik (1970) suggested, and that the sporadic surface responses observed in the cortex are the result of the filling-in process (Fig. 1B). On the other hand, plenty of oriented border contrast signals also exist from which surface color could be derived (Fig. 1C).

Surface and border signals during perceptual filling-in

The crucial question is how the surface and border signals behave during perceptual fading and filling-in. Consider a display as in Fig. 2 with two different colors, such as red in the center and green in the surrounding ring. If the isomorphic filling-in theory is right, then cells representing the center should signal "red" after stimulus onset, and then change to signal "green" when the display changes perceptually to a large uniform disc. For the border signals both theories predict a decline during fading: In the isomorphic theory, the cessation of border signals makes the disk borders permeable for color signals, in the symbolic theory, it causes the disk representation to vanish.

We have recorded the activity of cells in visual cortex while the monkey was performing the filling-in task (Friedman et al., 2002; see also Zhou et al., 2000 for general methods). "Surface cells" (as defined above) were tested with the uniform center of the disk placed over the receptive field, "edge cells" with the disk-ring border placed on the receptive field at the optimum orientation. Figs. 5 - 7 show the time courses of activity for four different stimulus

conditions (differences within stimulus conditions between trials in which the animal did and did not signal filling-in will be discussed later on).

Figure 5 shows the responses of a surface cell of area V1. The firing rate of the neuron is plotted as a function of time after stimulus onset. Each data point represents the mean firing rate during 0.5 s, error bars show standard errors of the means. Filled symbols and solid lines represent responses for disks of the "good" color (for this cell red), open symbols and dashed lines represent responses for disks of the "bad" color (green). The left side shows the activity during control trials in which the color of the disk was physically changed to that of the ring, the right side shows the activity during test trials in which the display was constant. The top panels are for blurred disks, the bottom panels for disks with sharp contours.

It can be seen that the firing rate in the test trials remained fairly constant, high for the optimum color, and low for the complementary color, during 6 s of fixation. Note also that the neural responses do not decay faster in the blurred than in the sharp border condition. By contrast, when the disk was filled in physically, the responses changed accordingly (left panels of Fig. 5). The firing rate followed the changing chromaticity rather faithfully. The two curves for good-to-bad and bad-to-good color changes cross each other.

A variety of color selective cells were tested. While red was the preferred color for the cell of Fig. 5, very similar results were obtained for green-selective cells. Using 8 pairs of equiluminant colors and 9 pairs of colors that differed in luminance including grays, we selected, for each cell, the pair that produced the greatest response difference. For Figs. 6--7 we calculated, for each cell, the difference between the responses to the two complementary color stimuli (solid and dashed curves of Fig. 5). (We assume here that color information is encoded in the balance of activity between pairs of cells with opposite color preference, but otherwise identical receptive fields. We infer the responses of the two cells from the responses of one cell to the two opposite colors.)

In Fig. 6 we have plotted the mean color signals of the surface cells tested in areas V1 and V2, weighting each cell by its color modulation index (difference between responses to optimal color and complementary color divided by the sum of the two). As in the previous Figure, the left panels represent the changing color condition, the right panels the constant color condition. Responses to sharp border stimuli are plotted with filled symbols and solid line, responses to blurred border stimuli with open symbols and dashed line. The results from areas V1 (where cells were recorded mainly from layers 2 and 3) and V2 are quite similar. It can be seen that the color surface signals crossed from positive to negative in trials in which the color of the disk changed from one color to its complement. However, when the stimulus colors did not change, the responses remained fairly constant. The finding of sustained color signals over 6 s is in contrast with the behavioral filling-in responses which indicated that in many trials the perceived color had changed to the complementary color by 6 s (80% of the trials in M13, 25% in M16, Fig. 4). Furthermore, the responses for the blurred and sharp border conditions are almost identical, in contrast to the behavioral filling-in responses which were more frequent for the blurred border than the sharp border.

As mentioned, the great majority of color sensitive cells are edge selective. We studied the responses of these cells to the border between disk and ring in our filling-in paradigm. Fig. 7 shows the time course of the color edge signals. As for the surface condition, we calculated the difference between the responses for the two color conditions, that is, the difference between the responses to edges of the preferred and nonpreferred polarities. Again, cells were weighted by

their color modulation index calculated as above, but from the responses to edges of opposite contrast polarities.

The predictions for border signals are different from those for surface signals. While the color of the disk changes to the complementary color, the contrast at the border between disk and ring decays to zero. As can be seen in Fig. 7, the color edge signals decreased to zero in the control trials, reflecting the contrast decay (left). However, the signals decreased also, more slowly, in the test trials in which the contrast was constant (right). This decay was faster for the blurred than the sharp border condition (dashed line versus solid line). A similar tendency can be seen also in the control trials.

We also looked at the difference within stimulus conditions between trials in which the monkeys signaled filling-in and those in which it did not. We expected to see an earlier drop of activity in trials with filling-in response. We found that the firing rate of the edge responses was slightly lower in these trials, while there was no difference in slope of decay, neither in the surface- nor in the edge responses. However, the behavioral data from the single cell recording sessions were less clear than the data from the psychophysical experiments (Friedman et al., 1999), presumably because during the recording sessions the animal had to switch back and forth between the difficult filling-in task and the simpler fixation task which was used to explore and map receptive fields, and also because stimulus location and color varied according to the receptive fields of the neurons studied.

Relating neural signals and behavioral response

In this section we discuss the question of how the time course of neural color signals should be related to the psychophysical data on filling-in. To illustrate the problem we consider a simple model. The logic is as follows: We assume that (1) perception of the disk color is based on the activity of a group of color selective cells, (2) a continuous signal S , such as a membrane potential, is derived by pooling and smoothing the spike trains, and (3) a filling-in response is generated when S reaches a critical limit. Whatever hypothesis we make about S , the same critical limit must account for the illusion as well as the perception of physical filling-in.

In the case of the isomorphic theory, S is derived from the surface signals. The disk appears to be filled in when its color signal equals that from the ring. We can determine the value of the disk color signal at this moment from the trials with physical color change: In the case of a sharp- edged disk whose color changed with a 1 s time constant the monkeys responded about 3 s after stimulus onset. From the plots of the neural signals of V2, for example, we see that the mean color surface signal had reached about -8 spikes/s at this time (filled circles in Fig. 6, bottom left panel). Thus, -8 spikes/s is the level of the color surface signal at which the disk blends in with the ring when the color changes physically, and this must be also the critical limit for illusory filling-in. In Fig. 8A we have replotted the surface response data for the blurred constant stimuli (open circles in Fig. 6, bottom right panel), and fitted a regression line to the data points. This line describes the slow decay of the color signal of the disk. The horizontal dotted line indicates the critical limit. (The sloping dashed line and the curve at the bottom are explained below.)

In the case of the symbolic theory, S is derived from edge cells and the critical limit should be zero because uniformity of color was the response criterion in the task. Indeed, the mean response of V2 edge cells at the time when filling-in was perceived for the physical color change (3 s) was close to zero (Fig. 7, lower left panel). In Fig. 8B we have replotted the mean

response data of the V2 edge cells for the blurred constant stimuli with their regression line. This line intersects zero at about 8 s.

Because the signal S varies from trial to trial, it can hit zero sooner or later than the mean signal. The signal characteristics of S depend on the variability of the single cell responses, the number cells pooled, their possible correlation, and the time constant of temporal integration. We do not know these parameters. However, since the probability of filling-in responses in the behavioral experiments started to rise at 3--4 s (Fig. 4), the standard deviation of S should be such that a line 2 SD below the regression line would intersect the limit at about 4 s. The dashed lines in Fig. 8B mark the ± 2 SD band assuming a SD of 4 spikes/s. This is the only free parameter in the model. The curve shows the approximate shape of the resulting probability distribution of model responses. It is comparable to the behavioral distributions of Fig. 4.²

In the case of the color surface signal, we would have to assume a much larger SD, in the order of 16 spikes/s, to obtain filling-in responses by 4 s (dashed line in Fig. 8A). However, because of the slow decay of the mean signal strength (the linear extrapolation reaches the limit only 25 s after stimulus onset), the probability of responses would rise extremely slowly. This is not at all what the behavioral responses show.³ The mismatch would be even greater for the color surface signals of V1 which are still more sustained than those of V2. Preliminary results from area V4 indicate that the color surface signals there are also sustained and do not change at the time of perceptual filling-in.

Discussion

Information about the color and brightness of a surface is represented in two ways in the visual cortex, by the activity of neurons whose receptive fields point at the surface, and by the responses of neurons whose receptive fields straddle the border of the surface.

Our recordings from the visual cortex of monkeys during perceptual filling-in failed to show the corresponding change of the surface activity. We conclude that the physiological evidence is incompatible with an isomorphic filling-in theory which assumes that color signals spread from the borders into uniform regions (Fig. 1B). We believe that our results do not depend on the particular choice of colors. We have used pairs of complementary colors for disk and ring (and switched them between trials to keep color adaptation constant). However, informal observations showed that similar filling-in would be obtained with other colors, for example, a gray patch surrounded by a colored ring or vice versa. We are aware that the comparison of neural signals with perception, even in the same animal, is fraught with problems. In our experiments, the stimulus parameters used for psychophysics and neural recording were not exactly the same. For example, the colors were varied in the physiological experiments, whereas only red and green were used for the psychophysical study, fixation of gaze might have varied, etc. However, even with these uncertainties in mind, it seems impossible to reconcile the sustained character of the color surface signals with the signal change postulated by the isomorphic filling-in theory.

The physiological data are compatible with a symbolic theory of filling-in which only postulates a decay of border signals (Fig. 1C). In this theory the perceived color of the blurred disk would be represented by the pooled color edge signals of the disk. Under reasonable assumptions about the variability of the pooled signal the distribution of behavioral filling-in responses can be modeled. Thus, the gradual decay of border signals might explain the delayed

perception of filling-in under conditions of image stabilization including Troxler's effect. Referring to Fig. 1C, we assume that the border signals sustain representations of two objects, a light disk on top of a dark square. The disk is perceived as long as the color edge selective cells are activated by the border of the disk. When their activity ceases, the disk representation disappears and a uniform square is perceived whose color is given by the cells that are activated by the borders of the square. In this theory, the cessation of all border activity inside a region is the condition for perceiving the region as uniform. We do not assume that uniformity is merely the default assumption; rather, we think that circuits exist which detect the absence of edge responses.

The proposition that object color is computed from border signals raises some interesting questions about the nature of the color edge signals and the way they are combined. The process of combination obviously requires information about which border signals have to be included and which not. In general this problem is more complex than in the case of a circular disk. Indeed, many psychophysical studies have shown that factors that determine the perception of spatial layout and contours also affect the perception of color and brightness. Examples are the brightness effect of illusory contours, perception of transparent colors, and brightness illusions in displays of 3D shapes (see for example, Kanizsa, 1979; Nakayama et al., 1990; Adelson, 1993). We conjecture that all these phenomena can be explained naturally by assuming that color and brightness are derived from orientation selective edge responses.

Of particular importance is the phenomenon of "border ownership", the tendency to perceive borders as belonging to one of the adjacent regions, as if the borders were occluding contours of objects in space (Koffka, 1935). We have recently shown that border ownership coding emerges early in the visual cortex. Edge selective cells in areas V2 and V4 were found to carry information about the side of the surface to which an edge belongs (Zhou et al., 2000; von der Heydt et al., 2002). In effect, each contrast border is represented by two groups of cells. For an isolated border, both groups are active, but if there are cues that indicate that a border is due to spatial occlusion, one group is activated while the other is suppressed. Such cells can be thought of as having receptive fields with a pointer that indicates the side of the surface to which the border belongs. In this representation, the color of a surface could be computed by selectively integrating the activity of those cells whose pointers converge towards the center of the surface. Future research might reveal this hypothetical stage of integration in the cortex.

The fact that the time course of the edge signals seems to explain naturally the delay and the rise of the probability of filling-in (Fig. 8B) suggests that filling-in is not entirely a process of the hypothetical stage of symbolic coding, but is initiated at the level of local feature representation. This is in agreement with psychophysical results showing that filling-in depends on stimulus properties such as movement, contrast, size, and blur (Spillmann et al., 1984; Zhang & von der Heydt, 1995).

Our finding that the color signals of surface cells did not reverse according to the perceptual color reversal indicates that these signals are not the result of a filling-in process as sketched in Fig. 1B, but simply reflect a property of the color signals from the retina. The finding of sustained activity in response to constant illumination of the receptive field contradicts the widespread opinion that responses in the visual pathways are generally transient (Walls, 1954; Gerrits & Vendrik, 1970). Sustained activity was the rule not only for color, but also for luminance contrast stimuli.

Given the behavioral evidence for a perceptual color reversal, the finding of sustained color surface signals is puzzling. It means that a perceptual color change, say, from red to green, can occur despite continued strong "red" signals from surface cells in V1 and V2. Although surface cells are only a small minority in these areas, the fact that such cells are found in V2 as well as V1 indicates that they do not merely represent a transitory stage of processing (Zhou et al., 2002). Perhaps these signals are not directly involved in representing object color, but serve to monitor illumination changes as required for color constancy.

Our results in the color/brightness domain are formally comparable to those of De Weerd et al. (1995) who found filling-in of neural texture responses in areas V2 and V3. The emergence of texture activity in neurons with receptive fields inside an untextured region of the stimulus in that study contrasts with the persistent absence of responses to disks of the non-preferred color of neurons in our study (Fig. 6). However, we have to keep in mind that the analogy is purely formal. Other observations also indicate that filling-in of texture is different from filling-in of color. For example, color filling-in produces an afterimage that depends on the adapting color, whereas the aftereffect of texture filling-in is not related to the texture of the preceding stimulation (Hardage & Tyler, 1995).

In conclusion, by comparing visual cortical neuron activity with behavioral responses in monkeys we find that the illusory perception of filling-in under steady fixation can be related to a gradual decay of color border signals. We find no evidence for surface filling-in at the level of neuronal signals. These findings suggest that the visual system computes surface color from orientation selective border responses.

Acknowledgments

We wish to thank Ofelia Garalde for technical assistance, and Todd Macuda for stylistic improvements. Supported by NIH grant EY02966 and Human Frontier Science Program RG31. HSF was supported by the Whitaker Foundation.

Footnotes

1 "Surface cell" is short for "surface-responsive cell" and does not imply a special role in surface representation.

2 The exact shape of the distribution depends on the power spectrum of S (cf. Gerstein & Mandelbrot, 1964). For example, if S varies rapidly, it would generally hit the critical limit before the mean. If it varies slowly, this would occur in about half of the trials. The curve in Fig. 8B corresponds to a slowly varying Gaussian signal.

3 We assumed that the limit is constant, i.e., that the color signal of the ring remains constant while the color signal of the disk changes, in keeping with the filling-in hypothesis. If the ring color signal also changes, but in opposite direction, the resulting probability of filling-in would rise faster, but would still reach only 5% after 6 s, compared to an average of 42% observed behavioral responses.

References

- Adelson EH (1993) Perceptual organization and the judgment of brightness. *Science* 262: 2042-2044.
- Arrington KF (1994) The temporal dynamics of brightness filling-in. *Vision Research* 34: 3371-3387.
- Cohen MA, Grossberg S (1984) Neural dynamics of brightness perception: features, boundaries, diffusion, and resonance. *Percept Psychophys* 36: 428-456.
- De Valois RL, Pease PL (1971) Contours and contrast: responses of macaque lateral geniculate cells to color and luminance figures. *Science* 171: 694-696.
- De Weerd P, Gattass R, Desimone R, Ungerleider LG (1995) Responses of cells in monkey visual cortex during perceptual filling-in of an artificial scotoma. *Nature* 377: 731-734.
- Ditchburn RW (1973) *Eye movements and visual perception*. Oxford: Clarendon.
- Fiorentini A, Baumgartner G, Magnussen S, Schiller PH, Thomas JP (1989) The perception of brightness and darkness: relations to neuronal receptive fields. In: *Visual perception: the neurophysiological foundations* (Spillmann L, Werner JS, eds), San Diego: Academic.
- Friedman HS, Zhou H, von der Heydt R (1999) Color filling-in under steady fixation: Behavioral demonstration in monkeys and humans. *Perception* 28: 1383-1395.
- Friedman HS, Zhou H, von der Heydt R (2002) Dynamics of color signals in monkey visual cortex during perceptual filling-in. Manuscript submitted for publication.
- Gerrits HJM, de Haan B, Vendrik AJH (1966) Experiments with retinal stabilized images. Relations between the observations and neural data. *Vision Res* 6: 427-440.
- Gerrits HJM, Vendrik AJH (1970) Simultaneous contrast, filling-in process and information processing in man's visual system. *Exp Brain Res* 11: 411-430.
- Gerstein GL, Mandelbrot B (1964) Random walk models for the spike activity of a single neuron. *Biophys J* 4: 41-68.
- Hardage L, Tyler CW (1995) Induced twinkle aftereffect as a probe of dynamic visual processing mechanisms. *Vision Res* 35: 757-766.
- Hubel DH, Wiesel TN (1968) Receptive fields and functional architecture of monkey striate cortex. *J Physiol (Lond)* 195: 215-243.
- Iarbus AL (1957) A new method of studying the activity of various parts of the retina. *Biophysics* 2: 165-167.
- Kanizsa G (1979) *Organization in Vision. Essays on Gestalt Perception*. New York: Praeger.
- Koffka K (1935) *Principles of Gestalt Psychology*. New York: Harcourt, Brace and World.
- Komatsu H, Murakami I (1994) Behavioral evidence of filling-in at the blind spot of the monkey. *Visual Neuroscience* 11: 1103-1113.
- Komatsu H, Kinoshita M, Murakami I (2000) Neural responses in the retinotopic representation of the blind spot in the macaque V1 to stimuli for perceptual filling-in. *J Neurosci* 20: 9310-9319.
- Krauskopf J (1963) Effect of retinal image stabilization on the appearance of heterochromatic targets. *J Opt Soc Am* 53: 741-743.
- Krauskopf J (1967) Heterochromatic stabilized images: a classroom demonstration. *Am J Psychol* 80: 634-637.
- Leventhal AG, Thompson KG, Liu D, Zhou Y, Ault SJ (1995) Concomitant sensitivity to orientation, direction, and color of cells in layers 2, 3, and 4 of monkey striate cortex. *Journal of Neuroscience* 15: 1808-1818.

- Levitt JB, Kiper DC, Movshon JA (1994) Receptive fields and functional architecture of macaque V2. *J Neurophysiology* 71: 2517-2542.
- Livingstone MS, Hubel DH (1987) Psychophysical evidence for separate channels for the perception of form, color, movement, and depth. *J Neuroscience* 7: 3416-3468.
- Michael CR (1978a) Color vision mechanisms in monkey striate cortex: Simple cells with dual opponent-color receptive fields. *J Neurophysiology* 41: 1233- 1249.
- Michael CR (1978b) Color-sensitive complex cells in monkey striate cortex. *J Neurophysiology* 41: 1250-1266.
- Murakami I, Komatsu H, Kinoshita M (1997) Perceptual filling-in at the scotoma following a monocular retinal lesion in the monkey. *Vis Neurosci* 14: 89-101.
- Nakayama K, Shimojo S, Ramachandran VS (1990) Transparency: relation to depth, subjective contours, luminance and neon color spreading. *Perception* 19: 497- 513.
- Paradiso MA, Nakayama K (1991) Brightness perception and filling-in. *Vision Research* 31: 1221-1236.
- Pessoa L, Thompson E, Noe A (1998) Finding out about filling-in: a guide to perceptual completion for visual science and the philosophy of perception. *Behav Brain Sci* 21: 723-748.
- Ratliff F (1978) A discourse on edges. In: *Visual Psychophysics and Physiology* (Armington JC, Krauskopf J, Wooten BR, eds), pp 299-314. New York: Academic.
- Riggs LA, Ratliff F, Cornsweet JC, Cornsweet TN (1953) The disappearance of steadily fixated visual test objects. *J Opt Soc Am* 43: 495-501.
- Spillmann L, Neumeier C, Hunzelmann N (1984) Adaptation an ruhende, bewegte und flimmernde Reize. *Klin Monatsbl Augenheilkunde Beiheft* 98: 68-78.
- Thorell LG, De Valois RL, Albrecht DG (1984) Spatial mapping of monkey V1 cells with pure color and luminance stimuli. *Vision Res* 24: 751-769.
- von der Heydt R, Zhou H, Friedman H (1996) The coding of extended colored figures in monkey visual cortex. *Soc Neurosci Abstr* 22: 951.
- von der Heydt R, Zhou H, Friedman HS (2002) Neural coding of border ownership: Implications for the theory of figure-ground perception. In: *Perceptual Organization in Vision: Behavioral and Neural Perspectives* (Behrmann M, Kimchi R, Olson CR, eds), Lawrence Erlbaum Associates.
- Walls GL (1954) The filling-in process. *Am J Optom* 31: 329-341.
- Wiesel TN, Hubel DH (1966) Spatial and chromatic interactions in the lateral geniculate body of the rhesus monkey. *J Neurophysiology* 29: 1115-1156.
- Yarbus AL (1967) *Eye movements and vision*. New York: Plenum Press.
- Zhang X (1995) Objective measurement of perceptual filling-in. Masters thesis. Johns Hopkins University, Baltimore MD.
- Zhang X, von der Heydt R (1995) Determinants of filling-in. *Invest Ophthalmol Vis Sci* 36: S469.
- Zhou H, Friedman HS, von der Heydt R (2000) Coding of border ownership in monkey visual cortex. *J Neuroscience* 20: 6594-6611.
- Zhou H, Friedman HS, von der Heydt R (2002) The coding of extended color figures in monkey visual cortex. Manuscript submitted for publication.

Figure captions

Fig. 1. Three theories about the neural representation of surface color. (A) The naive concept assumes that the color of the disk is represented by the cells whose receptive fields are distributed over the surface of the disk. (B) The color filling-in theory assumes that the color signals generated by receptive fields at the borders of the disk propagate to cells representing the interior of the disk. (C) The symbolic color representation theory assumes that the signals from edge selective receptive fields on the borders of the disk are integrated at a higher level to produce a signal that represents the color of the disk.

Fig. 2. The visual stimuli used to study color filling-in. The shapes of the stimuli are shown at the top, and chromaticity and luminance profiles at the bottom. The stimuli were disk-ring configurations in which the border between disk and ring could be sharp (left) or blurred (right). Either kind of stimulus was presented statically, and moving, the disk subscribing a circular path of 8 arc min radius at 1 Hz. The dimensions apply to the psychophysical experiments in which desaturated red and green colors were used. Similar configuration were used for the neural recordings, but colors were chosen according the color selectivity of each cell. (Modified from Friedman et al., 1999)

Fig. 3. Test trials and control trials. In test trials, disk and ring colors were constant. In control trials, the color of the disk was first constant for a variable interval, and then exponentially approached the ring color, with variable time constant. (Modified from Friedman et al., 1999)

Fig. 4. The probability of filling-in responses for the blurred disk-ring stimulus as a function of time after stimulus onset. The stimulus colors were constant, red and green. Distributions for 3 human subjects and 2 monkeys. (Modified from Friedman et al., 1999)

Fig. 5. The responses of a V1 cell to disk-ring stimuli centered over its receptive field in control trials (left) and test trials (right). Filled symbols, initial disk color optimal (red), open symbols, initial disk color complementary (green). Error bars represent standard errors of the means. Only one of 4 control conditions with different timing is shown: 1 s constancy with subsequent exponential change of 1 s time constant, vertical line indicates onset of change. -- When the disk color changed physically, the firing rate changed correspondingly (left), but during the perceptual color changes experienced with the blurred disk it remained nearly constant (top right). (From Friedman et al., 2002)

Fig. 6. The averaged color signals of the surface cells studied in V1 and V2 (V1 cells mostly from layers 2--3). The difference between the optimal and complementary color trials is plotted as a function of time after stimulus onset. Filled and open symbols represent sharp and blurred border conditions. Error bars represent standard error of the mean. As in the example of Fig. 5, the averaged surface signals followed the physical color changes, but remained nearly constant during perceptual changes. Note that stimuli with blurred and sharp borders produced very similar signals, whereas filling-in was perceived significantly more often with blurred than with sharp borders. (From Friedman et al., 2002)

Fig. 7. The averaged color signals of the edge cells of areas V1 and V2 (V1 cells mostly from layers 2--3). The border between disk and ring was placed in the receptive field at optimal orientation. The difference between responses to borders of optimal color contrast and the reversed contrast is plotted as a function of time. Other conventions as for Fig. 6. -- When the disk color changed physically, the edge signals followed the stimulus contrast, approaching zero within 3 s. When the colors were constant, the edge signals also decayed, but more slowly. The edge signals were significantly smaller for blurred disks than for sharp disks. (From Friedman et al., 2002)

Fig. 8. Model calculation relating neural signals to behavioral data. Predictions of the probability of behavioral filling-in responses are derived from (A) surface signals, and (B) edge signals, of V2. Dots with regression lines represent the averaged color signals of V2 cells (left scale) as a function of time after stimulus onset. The curve at the bottom indicates the predicted cumulative probability of filling-in (right scale). See Discussion for further explanation.

A

Color

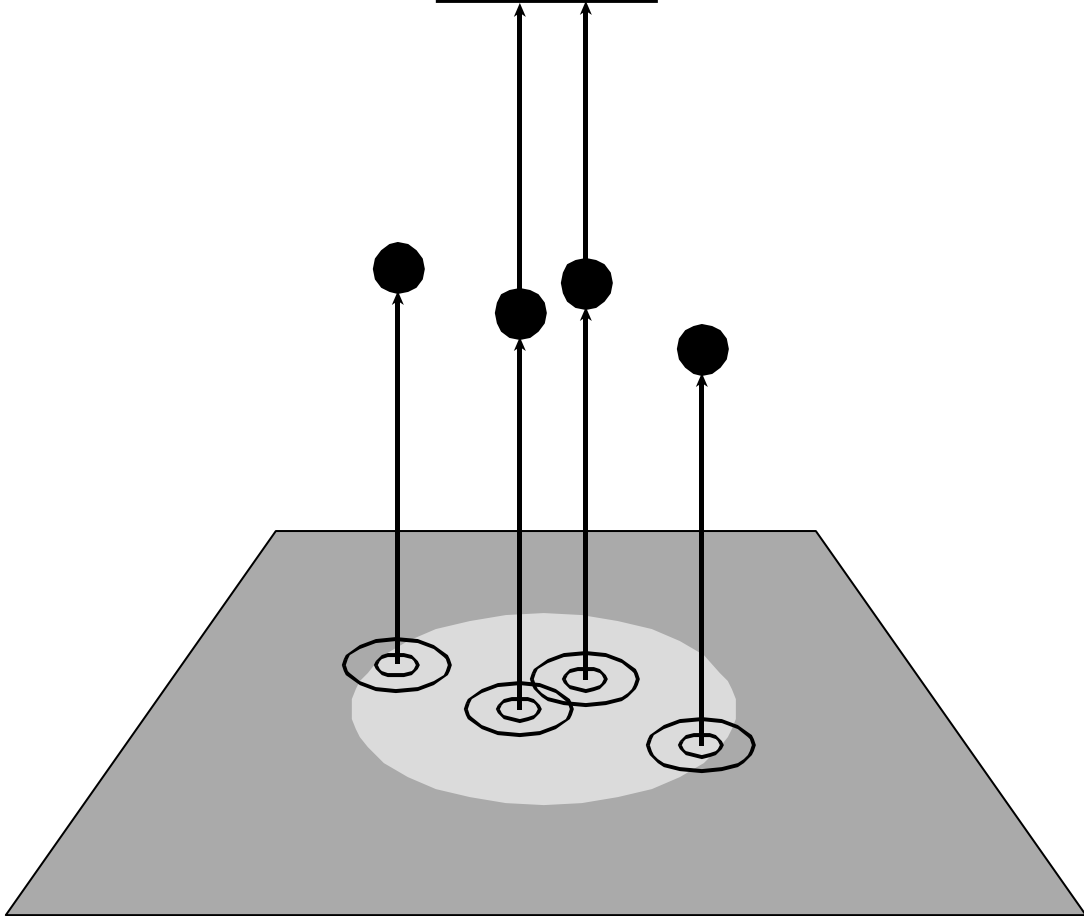

B

Color

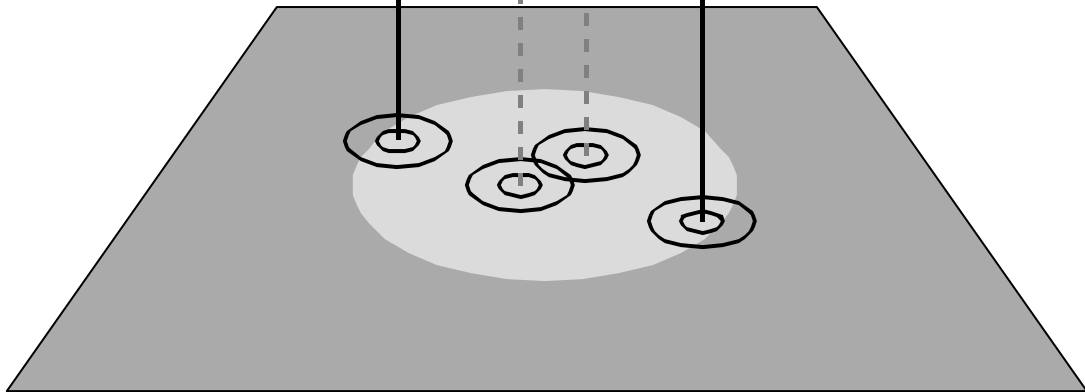

C

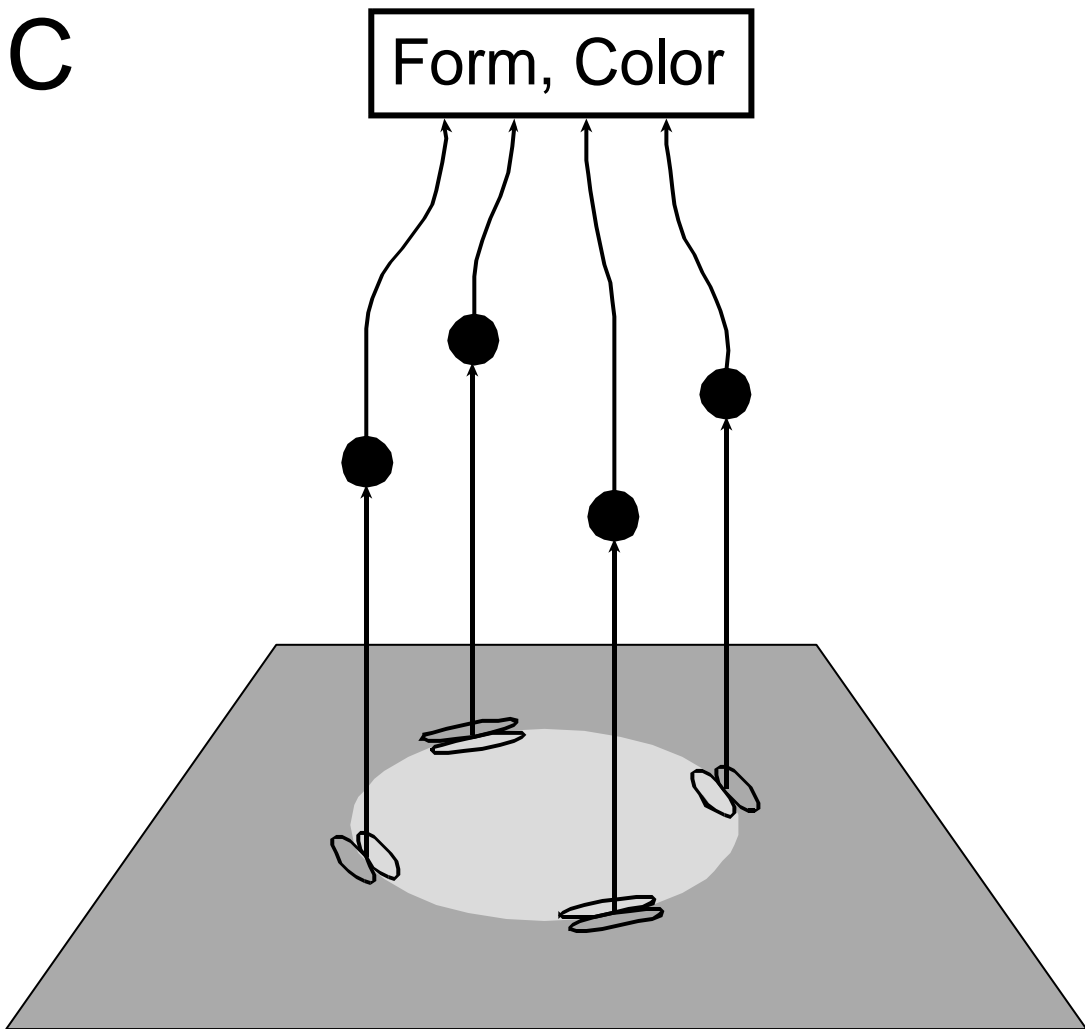

Sharp Edge

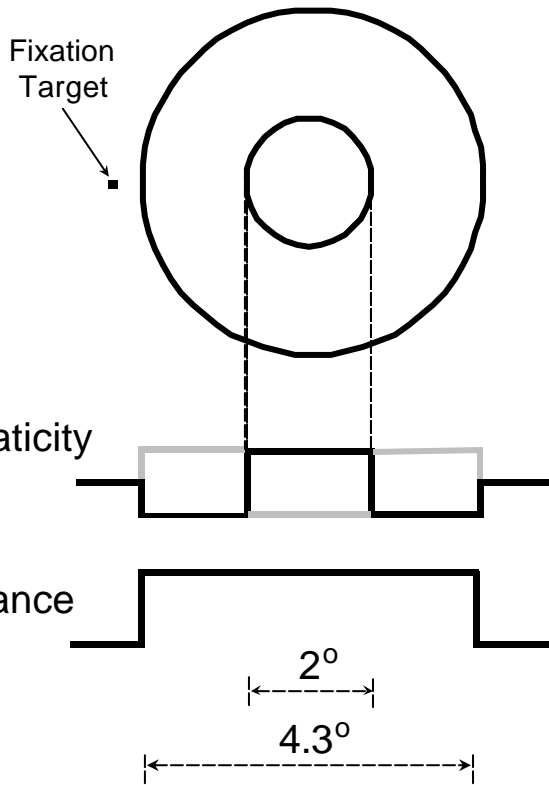

Blurred Edge

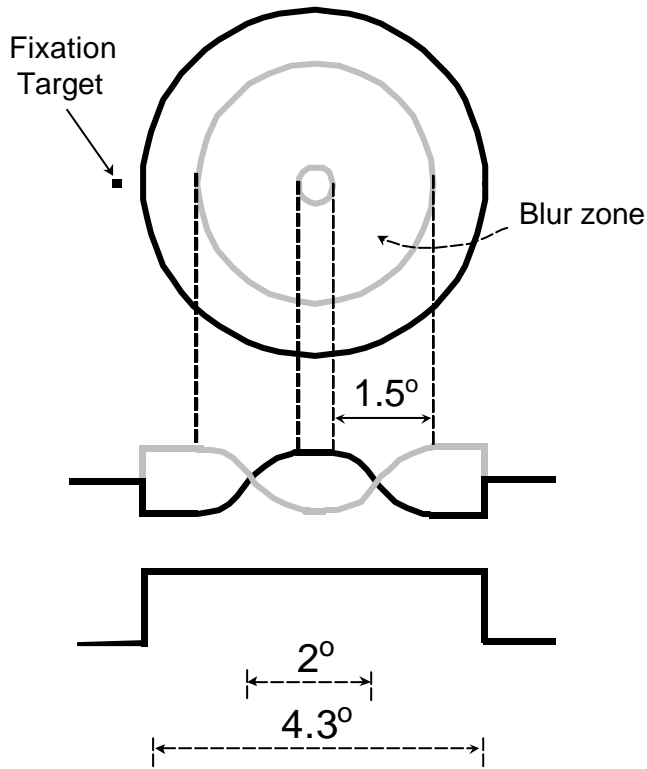

Control trials

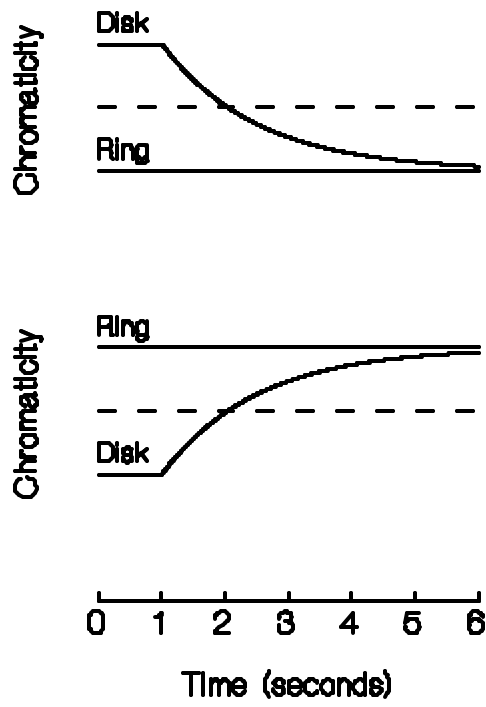

Test trials

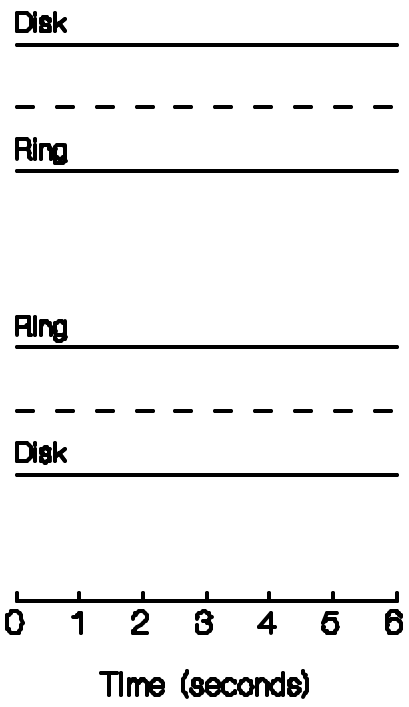

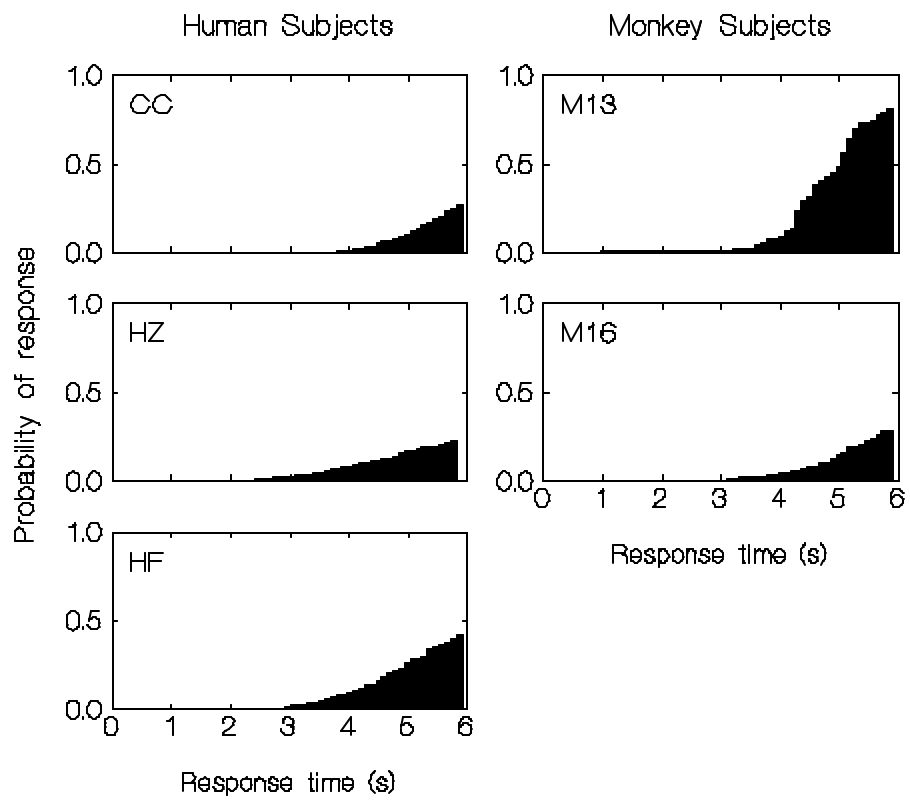

V1 surface cell

Changing stimulus

Constant stimulus

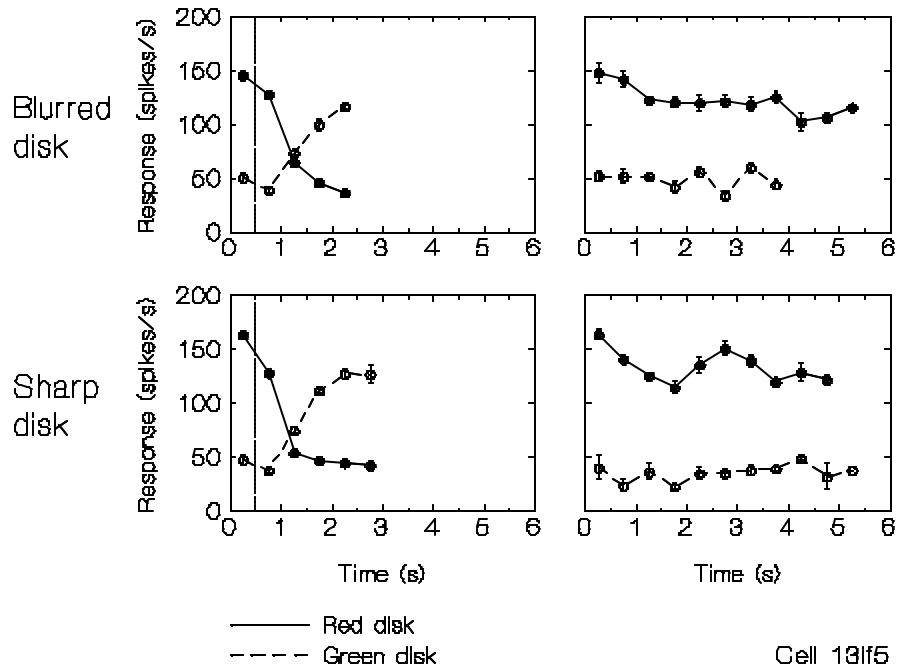

Surface Cells

Changing stimulus

Constant stimulus

V1 (n=24)

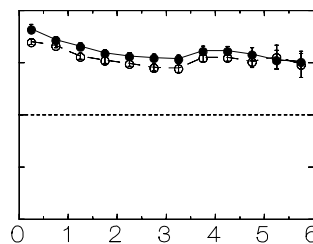
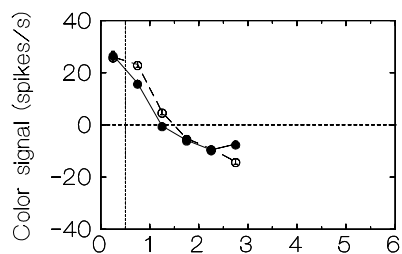

V2 (n=19)

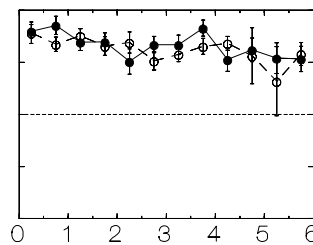
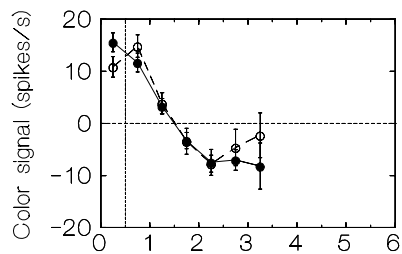

Time (s)

Time (s)

--- blurred

— sharp

Edge Cells

Changing stimulus

Constant stimulus

V1 (n=22)

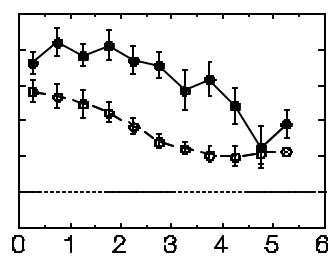
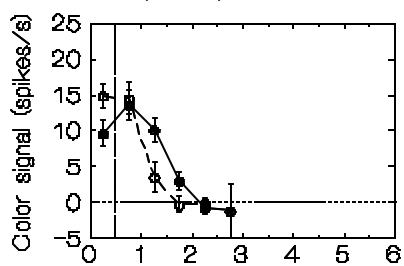

V2 (n=54)

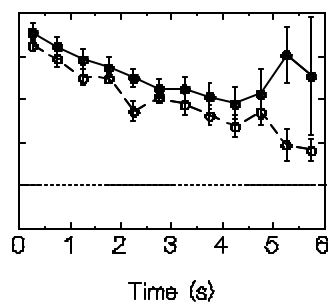
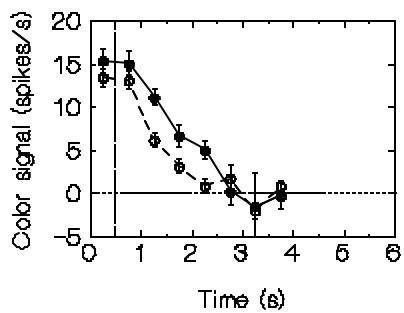

--- blurred
— sharp

A

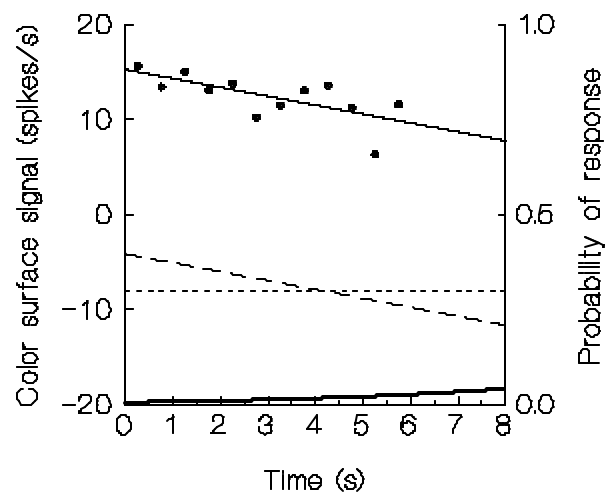

□

