

# Transport Layer Overview

Kai Shen

Dept. of Computer Science, University of Rochester

# Transport-layer Overview

- **Network layer:** host-to-host logical communication between *hosts*.
- **Transport layer:** logical communication between *applications*.
  - multiple comm. applications can reside in one host.
  - comm. applications can be a Web browser/server, a FTP client/server, etc.
- Transport layer: end-host-only implementation.

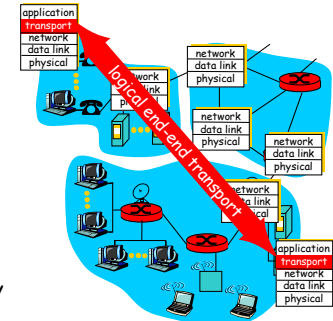

# Multiplexing/demultiplexing

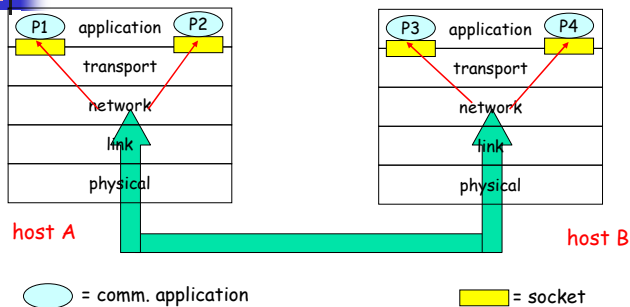

P1 on host A is communicating with P3 on host B; while at the same time, P2 on host A is communicating with P4 on host B.

# Transport-layer Service Model

- **Transport layer:** logical communication between *applications*.
  - multiplexing/demultiplexing
- Additional services:
  - reliable data transfer (guaranteed arrival, no error, in-order)
  - flow control (keep sender from overrunning receiver): good for myself
  - congestion control (keep sender from overrunning network): good for the community
  - delay/bandwidth guarantee
  - ...

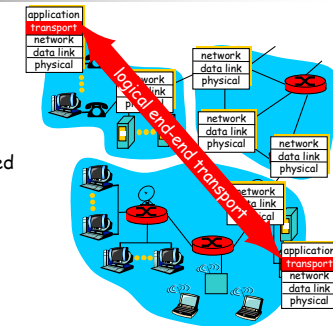

Why not these features at network layer?

## Internet Transport-layer Protocols

- UDP:
  - multiplexing/demultiplexing
  - error detection
- TCP:
  - multiplexing/demultiplexing
  - error detection
  - reliable data transfer
  - flow control
  - congestion control
- services not available:
  - delay guarantees
  - bandwidth guarantees
  - why?

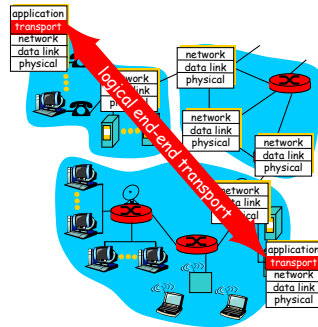

10/15/2007

CSC 257/457 - Fall 2007

5

## Internet Transport-layer Protocols (cont.)

- What is a *connection*?
  - logical relationship among data segments between the same pair of comm. end-points
  - allow for shared resources, basis for services such as in-order delivery, flow control, et al.
- UDP is *connectionless*:
  - each UDP segment handled independently of others
  - datagram-based service
- TCP is *connection-oriented*:
  - TCP segments between the same pair of comm. end-points are considered as belonging to a connection
  - stream-based service

10/15/2007

CSC 257/457 - Fall 2007

6

## Outline

- Overview of transport-layer services/protocols
- **Multiplexing and demultiplexing**
- Connectionless transport: UDP
- Principles of reliable data transfer
- Connection-oriented transport: TCP
  - reliable data transfer
  - flow control
  - connection management
- Principles of congestion control
- Congestion control in TCP

10/15/2007

CSC 257/457 - Fall 2007

7

## How multiplexing/demultiplexing works?



IP packet format

- **using port numbers**
  - each IP packet has source IP address, destination IP address
  - each IP packet carries a transport-layer segment
  - each segment has source, destination port number
- **dest. IP address** for routing to the host; **IP addresses and port numbers** for going to appropriate socket in the dest. host.

10/15/2007

CSC 257/457 - Fall 2007

8

## UDP Demultiplexing: An Example

- UDP socket identified by port number

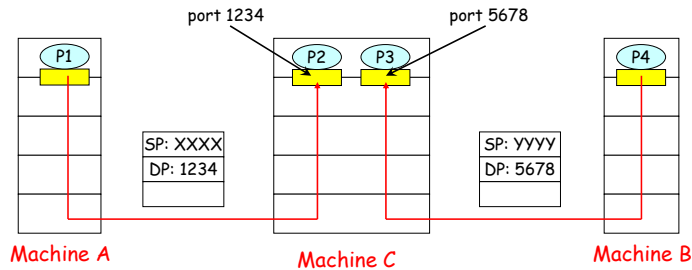

10/15/2007

CSC 257/457 - Fall 2007

9

## TCP Demultiplexing (Connection-oriented)

- TCP socket identified by 4-tuple:
  - (source IP address, source port number, dest IP address, dest port number)
  - recv host uses all four values to direct segment to appropriate socket
- Why?
  - each socket corresponds to a TCP connection
    - ⇒ Server at a port may support multiple simultaneous TCP connections/sockets
- Web server (on default port 80) has multiple sockets, one for each connecting client

10/15/2007

CSC 257/457 - Fall 2007

10

## TCP Demultiplexing: An Example

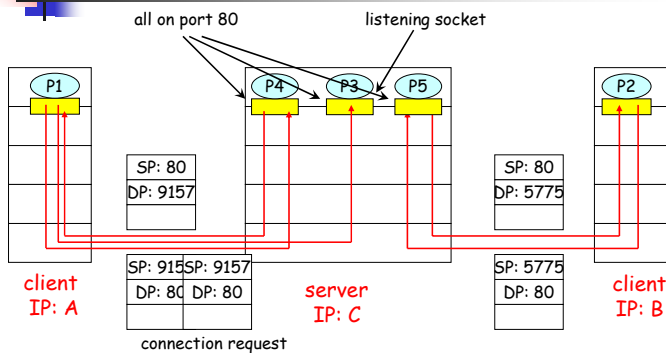

10/15/2007

CSC 257/457 - Fall 2007

11

## UDP: User Datagram Protocol

- UDP is connectionless
- UDP does
  - multplexing/demultiplexing
  - simple error detection
- UDP does not do
  - reliable data transfer, flow control, congestion control ...

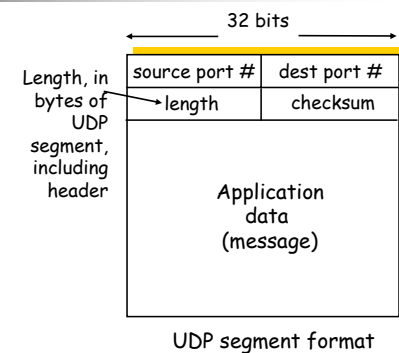

10/15/2007

CSC 257/457 - Fall 2007

12

## UDP Checksum

**Goal:** detect "errors" (e.g., flipped bits) in transmitted segments

### Sender:

- treat segment contents as sequence of 16-bit integers
- checksum: addition (1's complement sum) of segment contents
- sender puts checksum value into UDP checksum field

### Receiver:

- compute checksum of received segment
- check if computed checksum equals checksum field value:
  - NO: error detected
  - YES: no error detected.

Why are there error detections in transport, network, and link layers?

## What is good about UDP?

- TCP features may not be needed by some applications
- less overhead:
  - no connection establishment (which can add delay)
  - small segment header
  - no congestion control: UDP can blast away as fast as desired (may not be good for others, but not bad for my own connection 😊)
- simple: no connection state at sender, receiver

## UDP: More

- Often used for streaming multimedia apps
  - loss tolerant
  - rate sensitive
- In general, UDP is used when TCP features are not important
- What if you want features not in UDP while the full TCP is overkill?
  - implemented at application-level
  - flow control and loss recovery in some multimedia apps

## Disclaimer

- Parts of the lecture slides contain original work of James Kurose, Larry Peterson, and Keith Ross. The slides are intended for the sole purpose of instruction of computer networks at the University of Rochester. All copyrighted materials belong to their original owner(s).