

More on Link Layer



Kai Shen

2/4/2013
CSC 257/457 - Spring 2013
1

Recap of Last Class



- Ethernet
 - dominant link layer technology for local-area networks
 - Ethernet frame size
 - Ethernet multiple access control
 - CSMA/CD, exponential back-off
 - factors for its efficiency
 - Speed: 10Mbps, 100Mbps, 1Gbps, 10Gbps, ...
- Link-layer addresses
 - Static per-device, universally unique
 - ARP
 - Why multiple addresses at multiple layers?

2/4/2013
CSC 257/457 - Spring 2013
2

Interconnecting Nodes in Local-Area Networks

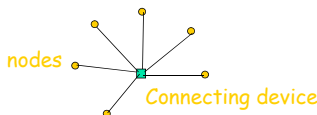

- **Hubs**: physical-layer signal repeaters.
- **Bridges**: smarter, understands link-layer protocol (Ethernet).
- **Switches**: essentially bridges with large number of ports.

2/4/2013
CSC 257/457 - Spring 2013
3

Interconnecting with Hubs



- **Physical-layer** repeater
 - Repeat signal on all outgoing links
 - Doesn't care whether links are busy or not
 - No buffering
- **Problems**:
 - Simultaneous traffic from multiple segments may collide
 - Can't interconnect links at different speeds

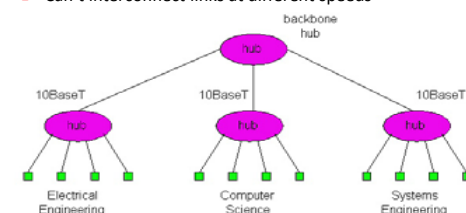

2/4/2013
CSC 257/457 - Spring 2013
4

Bridges

- **Link layer device**
 - understands and participates in Ethernet
 - buffers frame, uses CSMA/CD to access link
 - traffic isolation ⇒ **selectively** forwards frame based on dest. address (avoid flooding all links)

How to determine to which LAN segment to forward frame?

2/4/2013 CSC 257/457 - Spring 2013 5

Self Learning

- A bridge has a **bridge table**
 - each entry: (Dest. address, bridge interface, timestamp)
- bridges **learn** which host is connected through which interface
 - when frame received, bridge “learns” location of sender: incoming LAN segment
 - records sender/location pair in bridge table

2/4/2013 CSC 257/457 - Spring 2013 6

Bridge Example

address	port
A	1
B	1
E	2
H	3
J	3

- Bridge receives frame from C destined to D
 - bridge learns C is on interface 1
 - because D is not in table, bridge floods
- Another frame from C to D?
- Frame received by D, then a reply is sent back to C
 - bridge learns D is on interface 2
 - in bridge table C is on interface 1, so bridge **selectively** forwards frame to interface 1

2/4/2013 CSC 257/457 - Spring 2013 7

Bridge Forwarding

- When to start forwarding?
 - **stop and forward**: frame is completely buffered before forwarded to the next hop
 - **cut-through forwarding**: frame forwarded from input to output port without awaiting for assembly of entire frame
 - reduction in latency
 - implication on Ethernet frame structure?

2/4/2013 CSC 257/457 - Spring 2013 8

Important Bridge Features

- Isolates collision domains resulting in higher total throughput
- “Plug-and-play”: no configuration necessary
- Buffering allow links of different speeds on a single bridge: 100Mbps/1Gbps interfaces
- Cut-through forwarding

2/4/2013
CSC 257/457 - Spring 2013
9

Ethernet Switches

- Essentially a bridge with a large number of ports
 - ⇒ so many ports that each host can connect to one
- After self-learning
 - A-to-A' and B-to-B' simultaneously at full link speed, no collisions
 - Ethernet but no collisions for simultaneous uses
 - How about congestion?

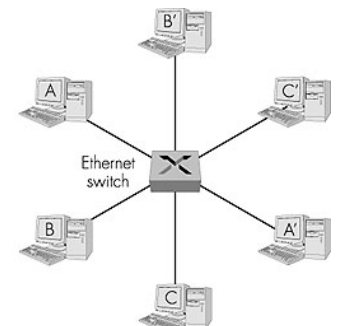

2/4/2013
CSC 257/457 - Spring 2013
10

Ethernet Switch Scalability

- Switch allows simultaneous traffic at full link speed How does it scale?
- Switch architectures
 - Bus
 - Crossbar
- A switch with a large number of ports
 - High implementation complexity ⇒ costly to build

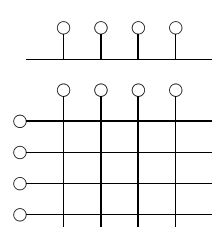

2/4/2013
CSC 257/457 - Spring 2013
11

Switch Interconnection (no enough ports on a single switch)

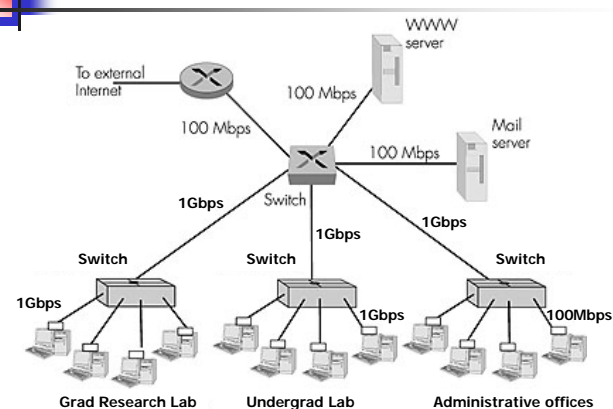

2/4/2013
CSC 257/457 - Spring 2013
12

Network Switching at Internet Server Center

- Thousands of servers with hierarchical network switching

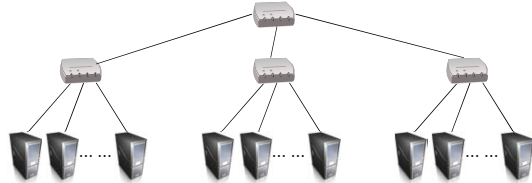

- Reduce congestions:
 - Network load balance across nodes
 - Place highly communicating server modules within same switch domain, or better yet, in same machines
 - Redundancy at backbone links

2/4/2013

CSC 257/457 - Spring 2013

13

Summary Comparison

- Hubs
 - little more than a physical-layer signal repeater, no traffic isolation, buffering
- Bridges
 - understands link-layer protocol (Ethernet), supports smarter forwarding, traffic isolation
 - supports different Ethernet speeds with buffering
- Switches
 - essentially bridges with large number of ports
 - no collision, but congestion is possible at individual links
 - widespread usage today!

2/4/2013

CSC 257/457 - Spring 2013

14

Media Access Control in Wireless LAN -- IEEE 802.11

- Collision if 2 or more nodes transmit at same time
- Can we use CSMA/CD?
 - hidden terminal problem \Rightarrow carrier sense and collision detection don't work
- Repair carrier sense:
 - carrier probing
- Repair collision detection:
 - success acknowledgement

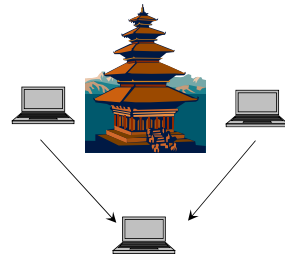

2/4/2013

CSC 257/457 - Spring 2013

15

PPP (point-to-point protocol)

- one sender, one receiver, one link:
 - no Media Access Control
 - no need for explicit MAC addressing
 - simpler than broadcast link
- deployed in
 - dialup links over telephone lines
 - long-haul fiber-optics links

2/4/2013

CSC 257/457 - Spring 2013

16

Link Virtualization

- What is a link?
 - physical wire
 - connection between two IP network-aware nodes
- Virtual link
 - in the case of switched Ethernet?
 - in the case of PPP modem link?
- Why virtual link?
 - flexibility of technology evolution
 - link up legacy networks

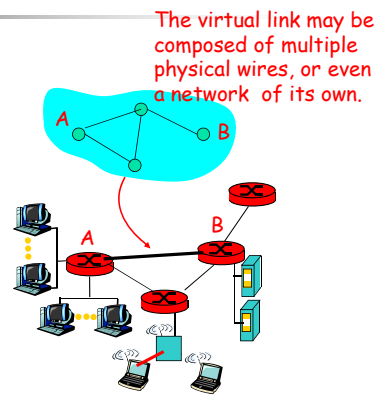

2/4/2013

CSC 257/457 - Spring 2013

17

Link Virtualization

- ATM (asynchronous transfer mode)
 - a multilayer network architecture at its own
 - mainly designed for supporting real-time multimedia, with connection-oriented resource reservation
 - deemed as link layer protocols in Internet architecture → IP over ATM
- Frame relay
 - origins in telephony world
 - Like ATM, a network architecture at its own, with connection-oriented resource reservation
 - can be used to carry IP datagrams → IP over frame relay

2/4/2013

CSC 257/457 - Spring 2013

18

Disclaimer

- Parts of the lecture slides contain original work of James Kurose, Larry Peterson, and Keith Ross. The slides are intended for the sole purpose of instruction of computer networks at the University of Rochester. All copyrighted materials belong to their original owner(s).

2/4/2013

CSC 257/457 - Spring 2013

19