

# **CSC 252: Computer Organization**

## **Spring 2021: Lecture 14**

Instructor: Yuhao Zhu

Department of Computer Science  
University of Rochester

# Announcements

- Programming assignment 3 is out
  - Details: <https://www.cs.rochester.edu/courses/252/spring2021/labs/assignment3.html>
  - Due on **March 23**, 11:59 PM
- Lab 2 grades are out.

7	8	9	10	11	12	13
14	15	16	17	18 <b>Today</b>	19	20
21	22	23 <b>Due</b>	24	25 <b>Mid-term</b>	26	27

# Announcements

# Announcements

- Mid-term exam: **March 25**; online.
- Past exam & Problem set: <https://www.cs.rochester.edu/courses/252/spring2021/handouts.html>
- Exam will be electronic using Gradescope, but we will send you an PDF version so that you can work offline in case
  - 1) you don't have Internet access at the exam time or
  - 2) you lose Internet access.
  - Write down the answers on a scratch paper, take pictures, and send us the pictures
- We will have a mock exam next Tuesday (~5 mins).

# Announcements

# Announcements

- Open book test: any sort of paper-based product, e.g., book, **notes**, magazine, old tests.
- Exams are designed to test your ability to apply what you have learned and not your memory (though a good memory could help).
- **Nothing electronic (including laptop, cell phone, calculator, etc) other than the computer you use to take the exam.**
- **Nothing biological**, including your roommate, husband, wife, your hamster, another professor, etc.
- **“I don’t know”** gets 15% partial credit. Must erase everything else.

# Pipeline Trade-offs

- Pros: Decrease the total execution time (Increase the “**throughput**”).
- Cons: Increase the latency of each instruction as new registers are needed between pipeline stages.

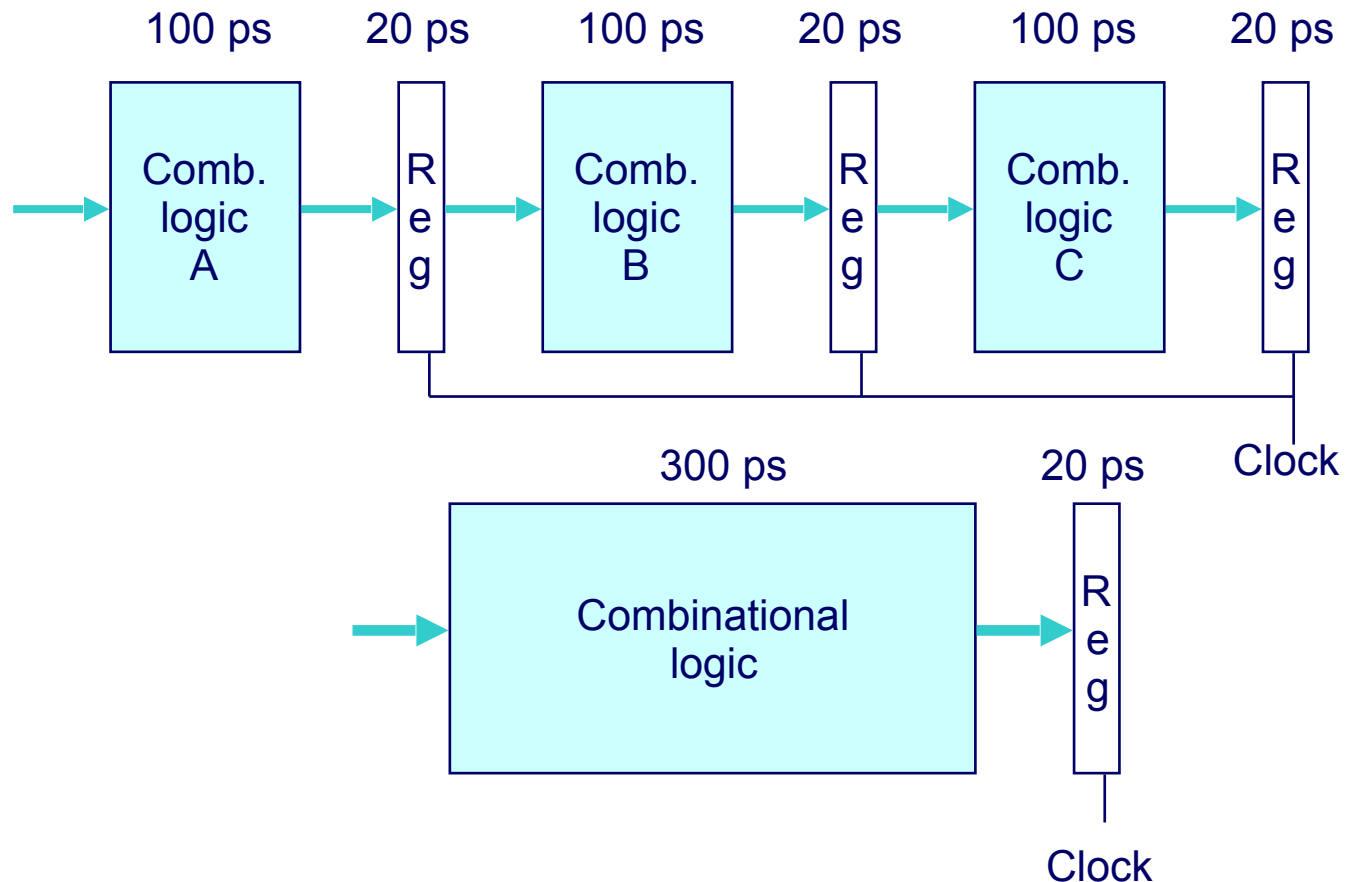

# Throughput

- The rate at which the processor can finish executing an instruction (at the steady state).

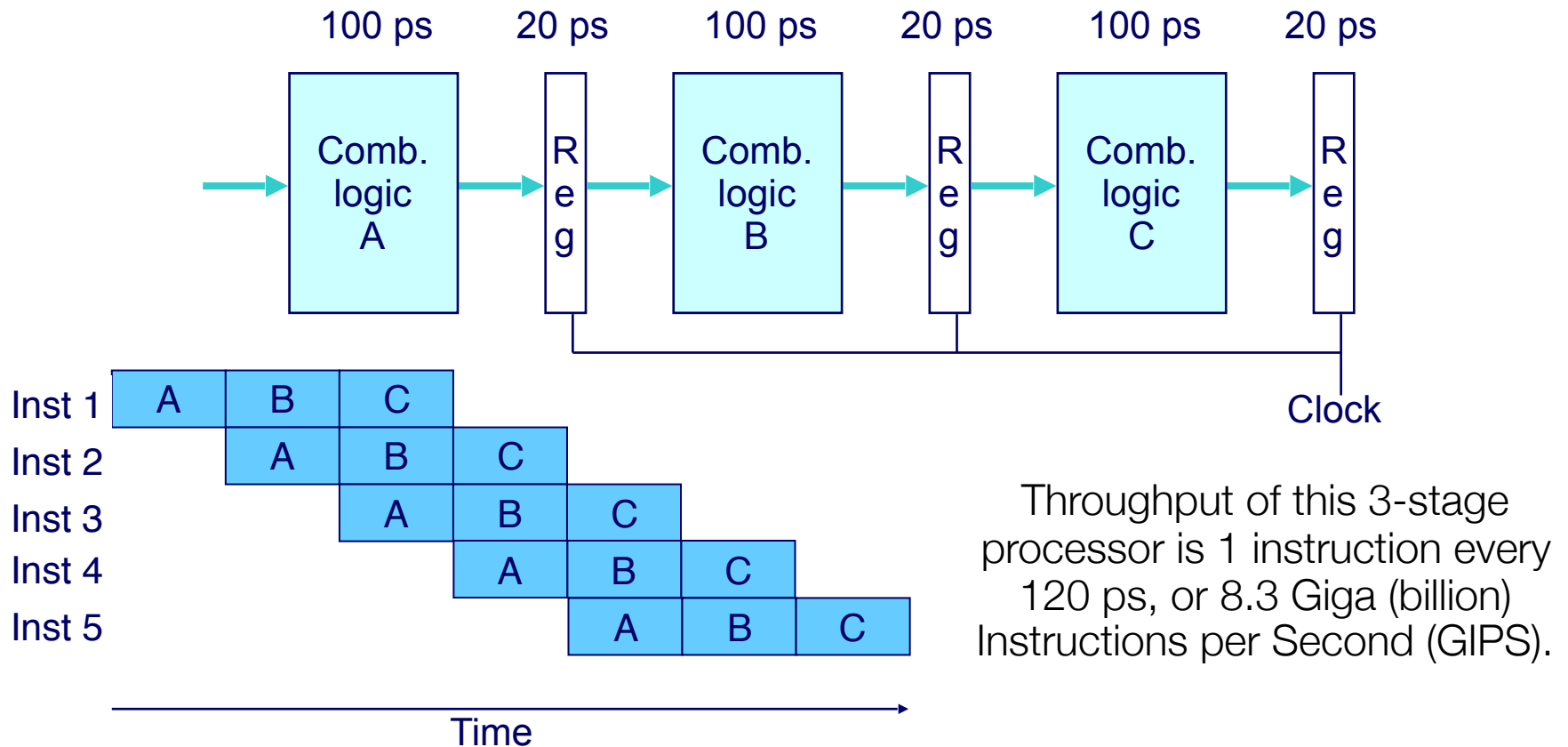



# Aside: Unbalanced Pipeline

- A pipeline's delay is limited by the slowest stage. This limits the cycle time and the throughput

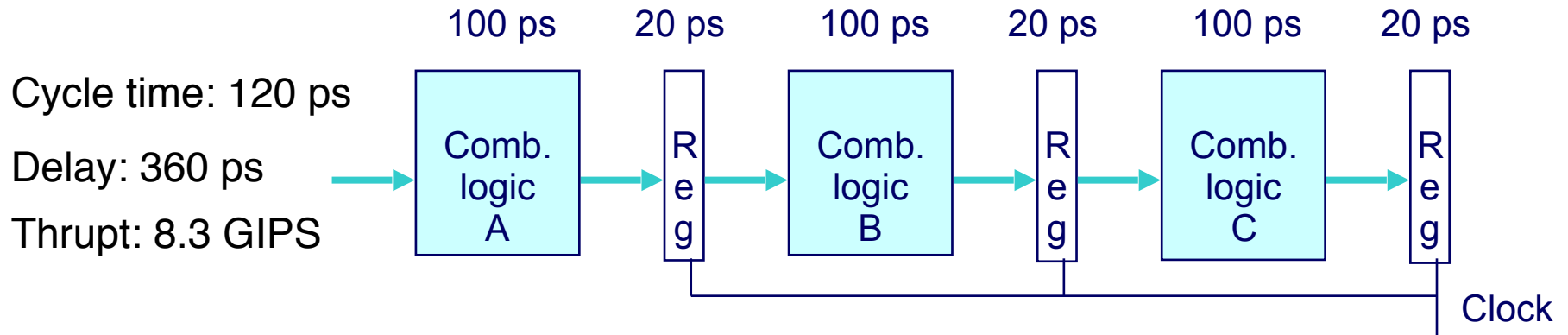

# Aside: Unbalanced Pipeline

- A pipeline's delay is limited by the slowest stage. This limits the cycle time and the throughput

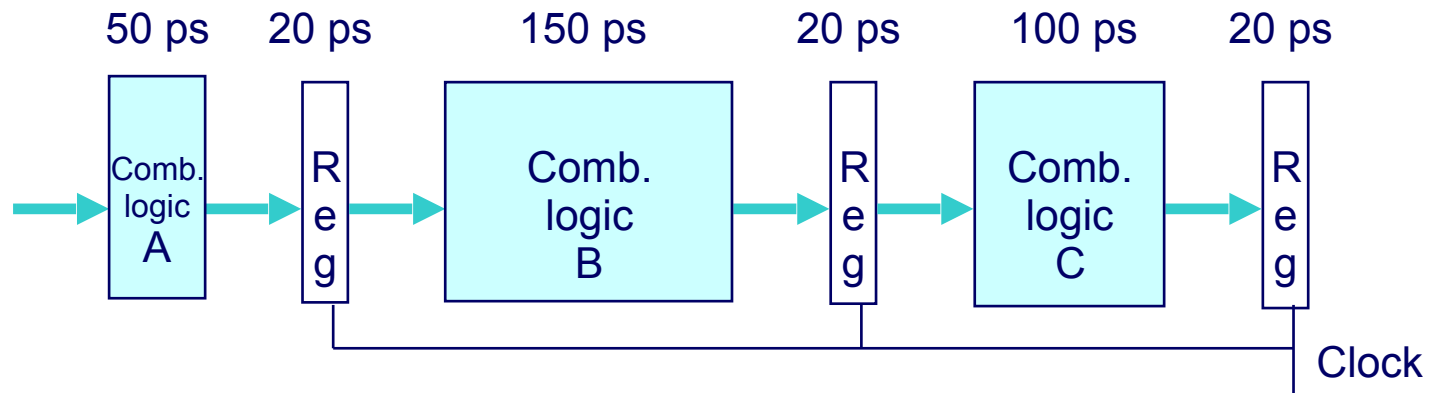
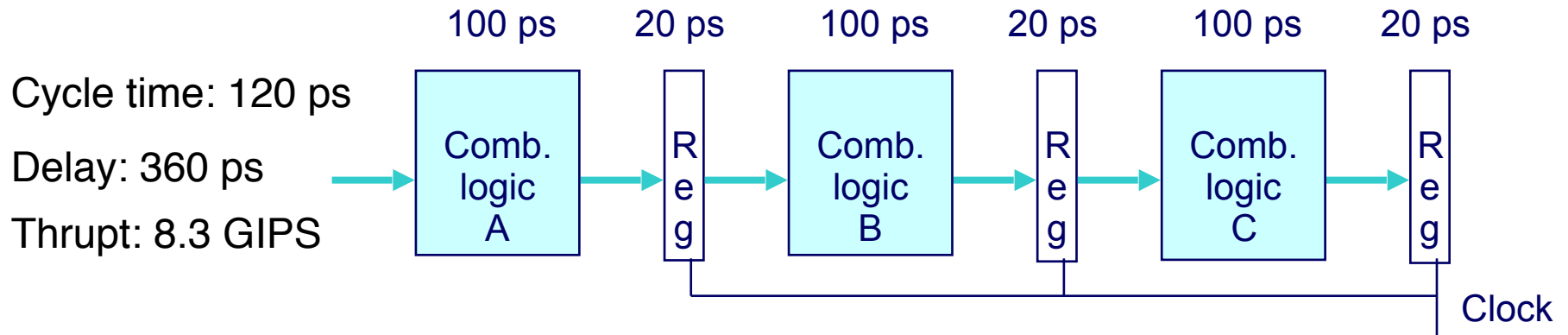

# Aside: Unbalanced Pipeline

- A pipeline's delay is limited by the slowest stage. This limits the cycle time and the throughput

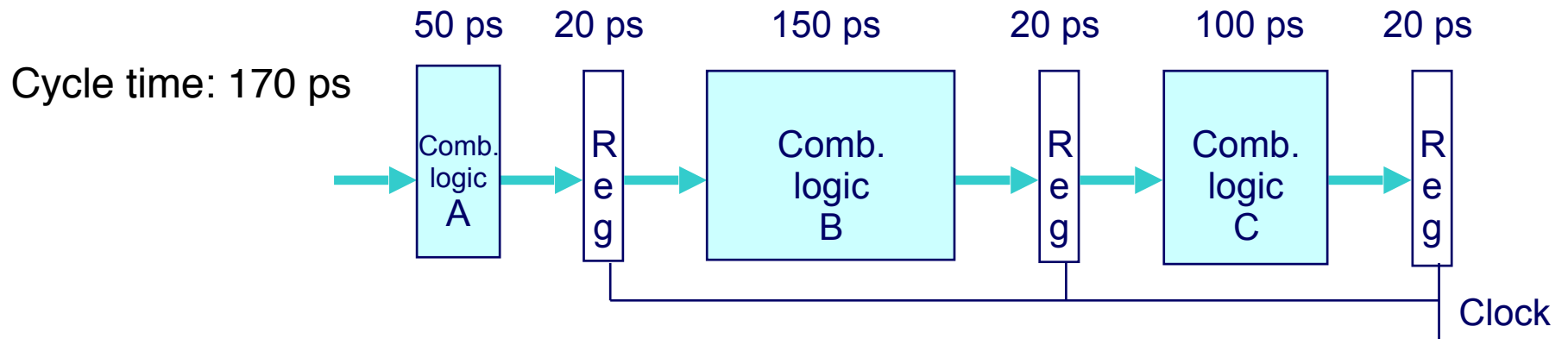
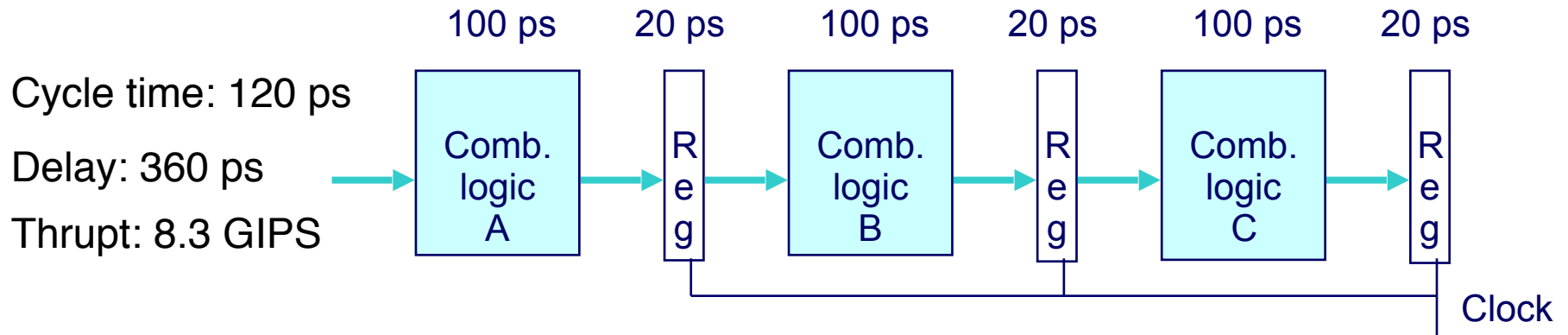

# Aside: Unbalanced Pipeline

- A pipeline's delay is limited by the slowest stage. This limits the cycle time and the throughput

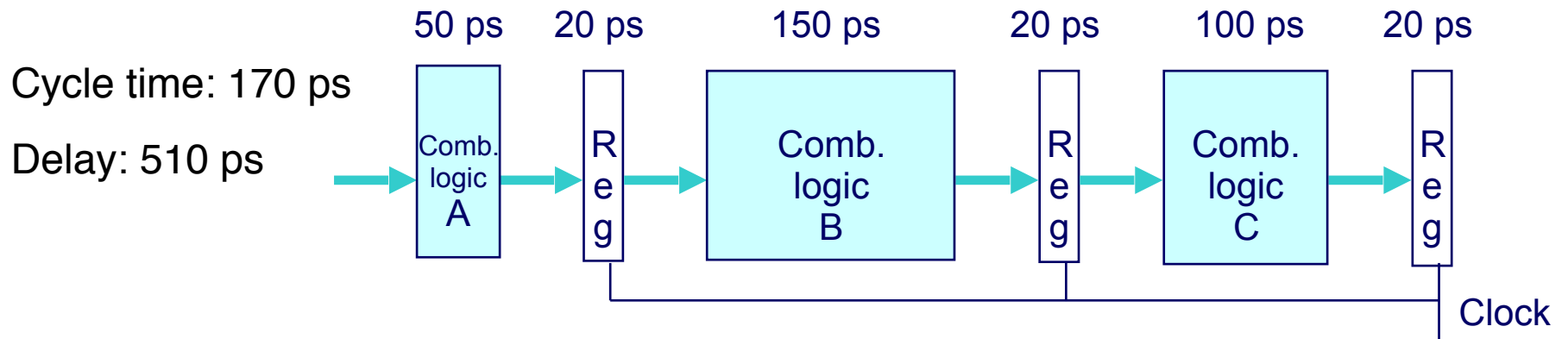
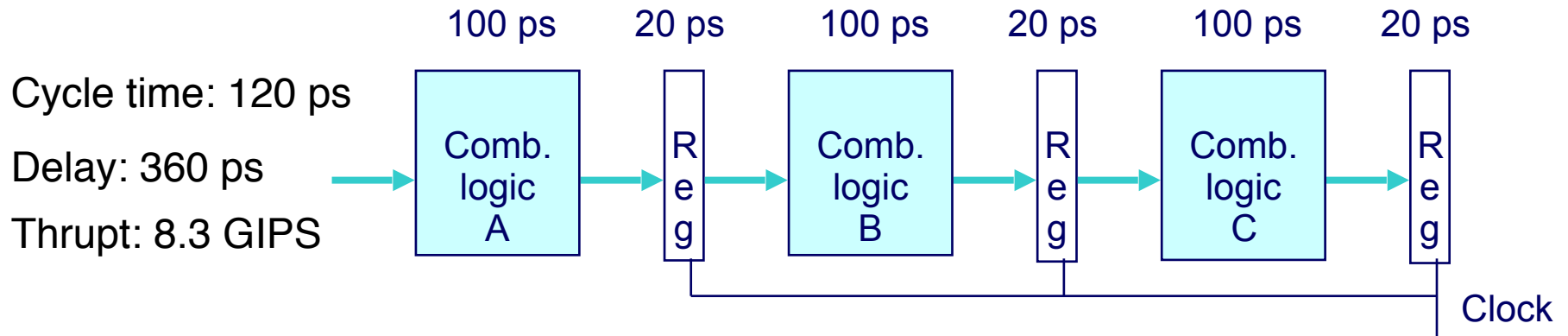

# Aside: Unbalanced Pipeline

- A pipeline's delay is limited by the slowest stage. This limits the cycle time and the throughput

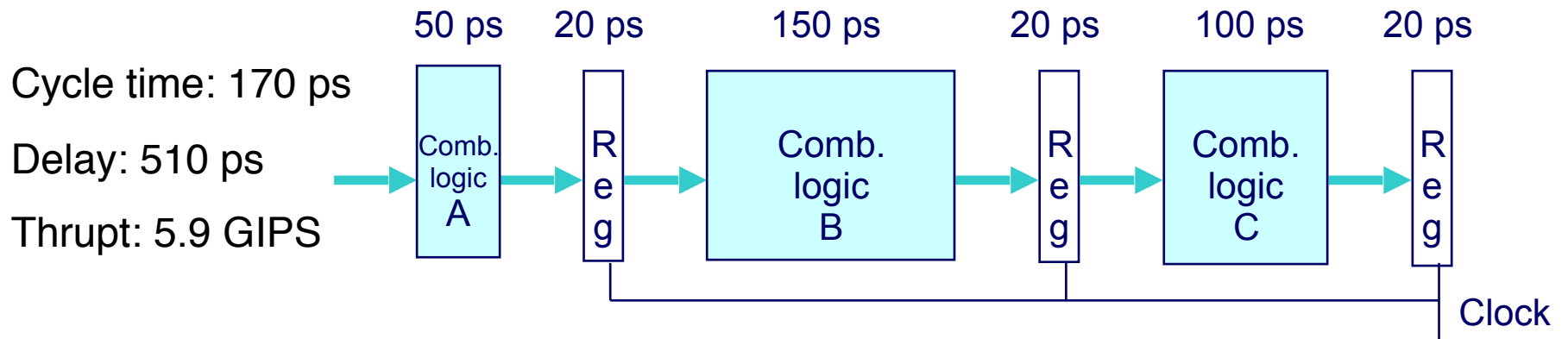
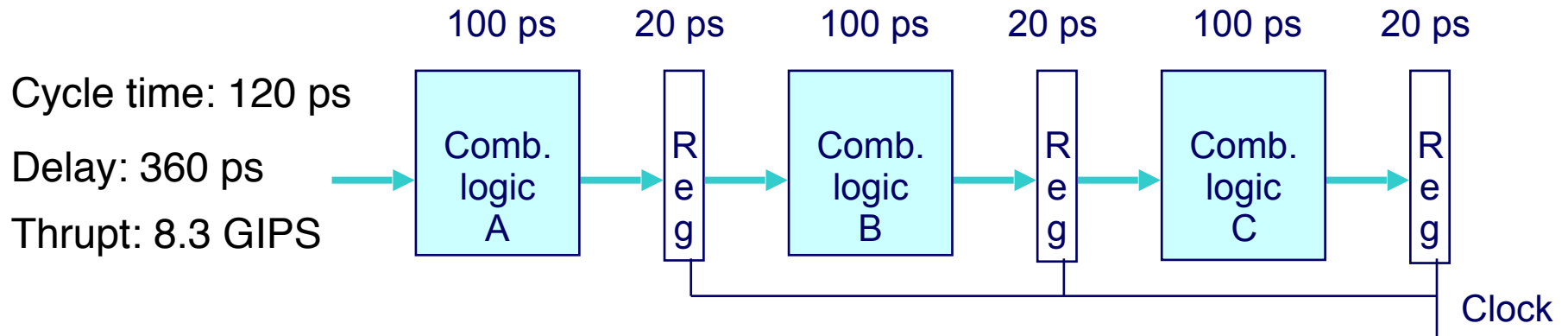

# Aside: Unbalanced Pipeline

- A pipeline's delay is limited by the slowest stage. This limits the cycle time and the throughput

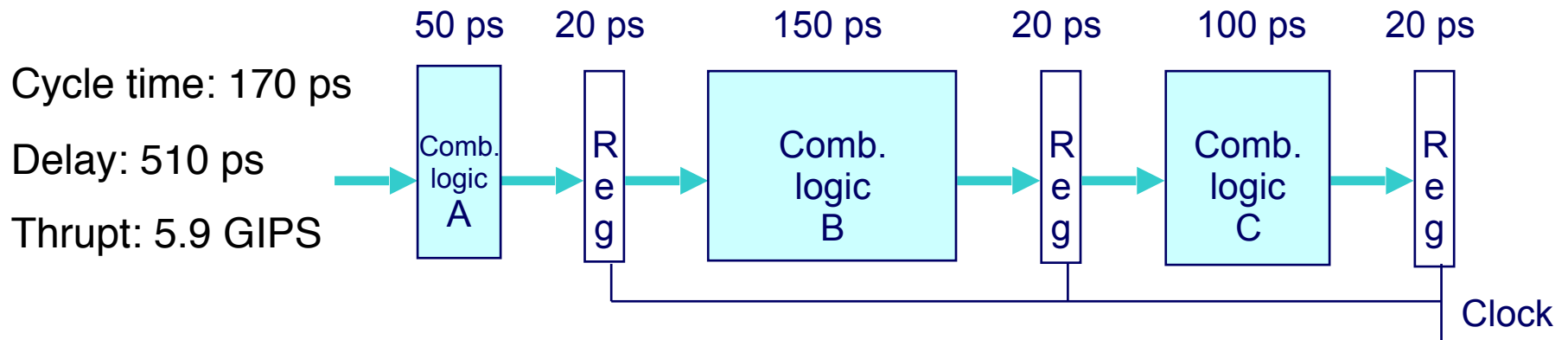
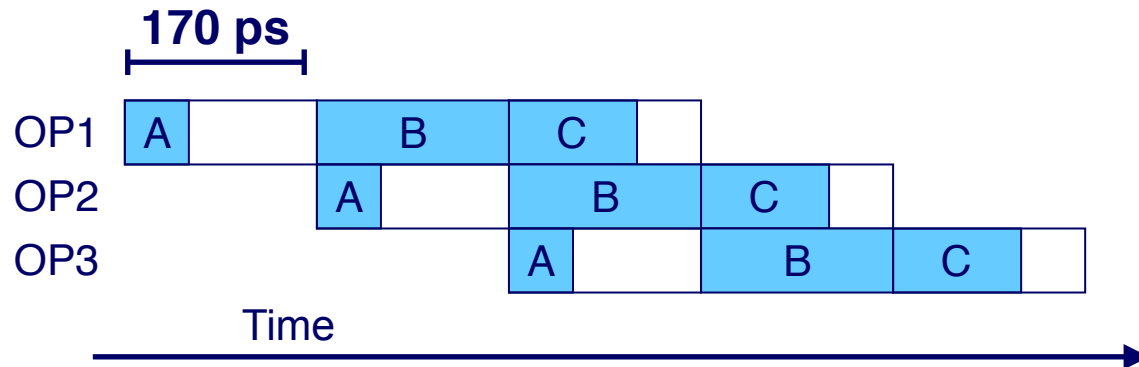

# Aside: Mitigating Unbalanced Pipeline

- Solution 1: Further pipeline the slow stages

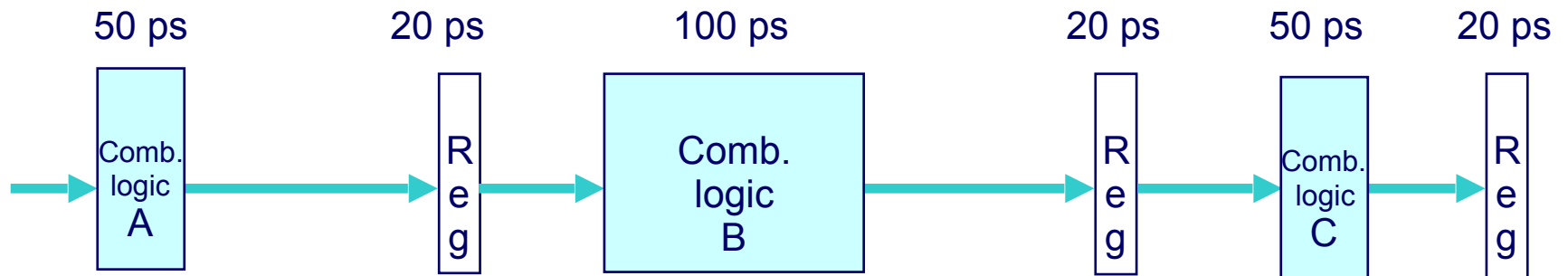

# Aside: Mitigating Unbalanced Pipeline

- Solution 1: Further pipeline the slow stages
  - Not always possible. What to do if we can't further pipeline a stage?

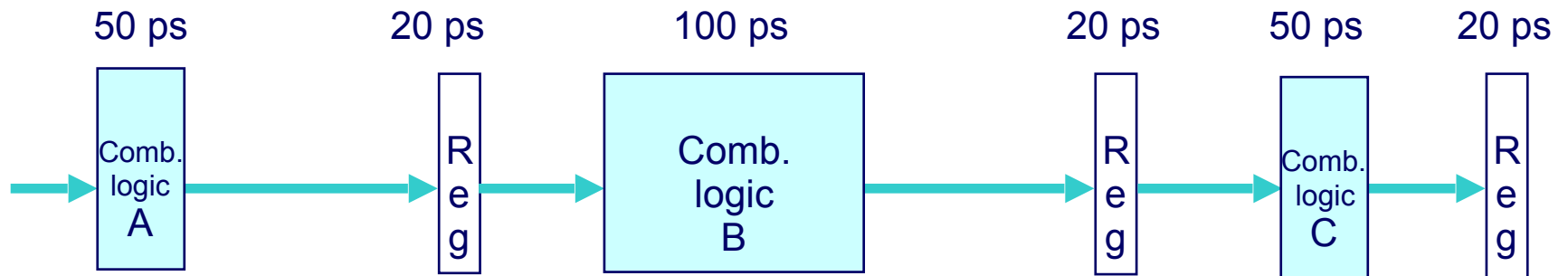



# Aside: Mitigating Unbalanced Pipeline

- Solution 1: Further pipeline the slow stages
  - Not always possible. What to do if we can't further pipeline a stage?
- Solution 2: Use multiple copies of the slow component

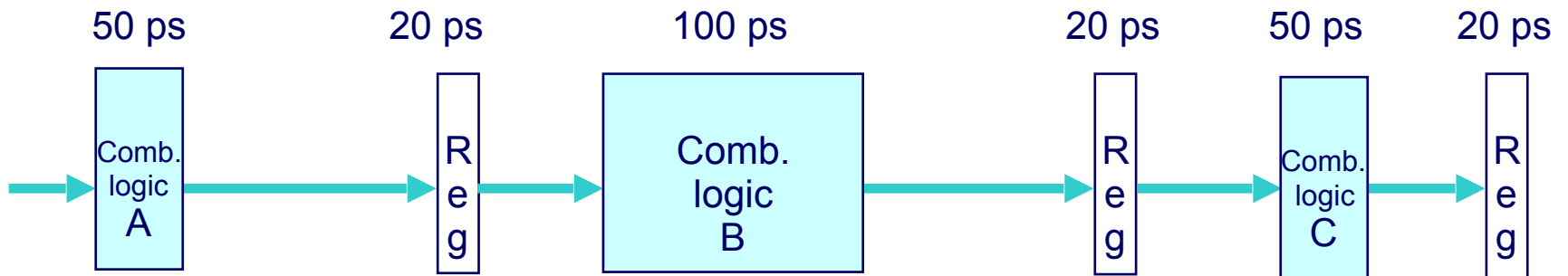

# Aside: Mitigating Unbalanced Pipeline

- Solution 1: Further pipeline the slow stages
  - Not always possible. What to do if we can't further pipeline a stage?
- Solution 2: Use multiple copies of the slow component

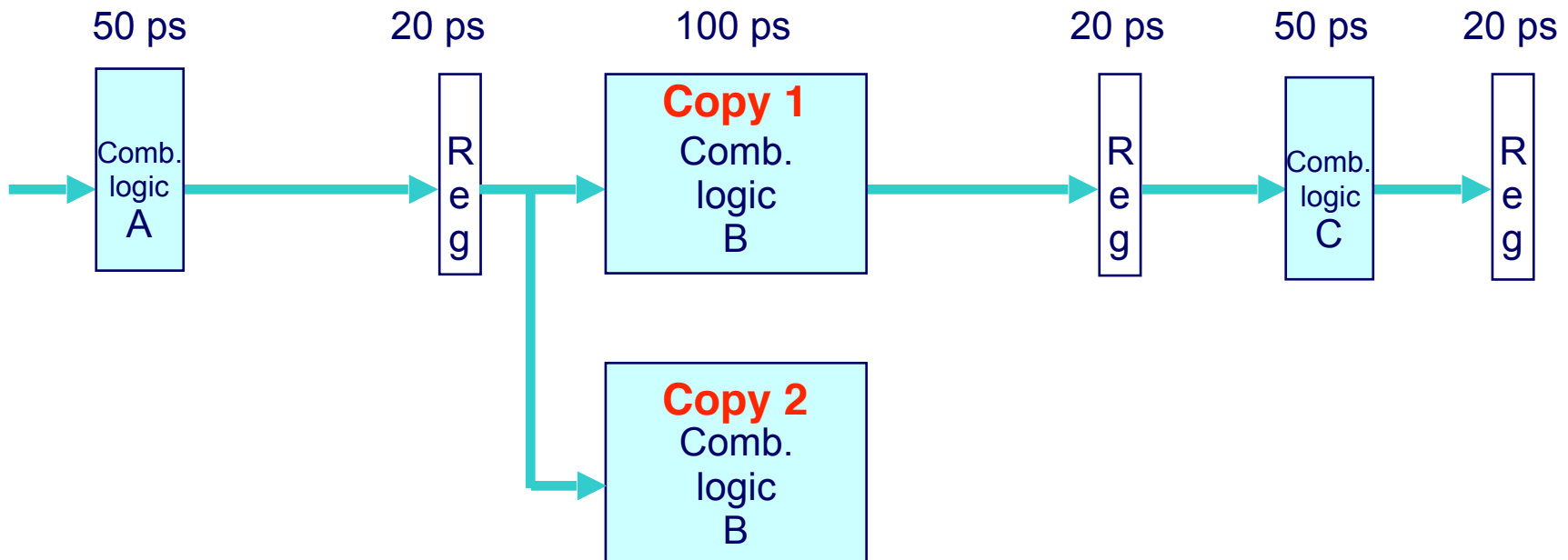

# Aside: Mitigating Unbalanced Pipeline

- Solution 1: Further pipeline the slow stages
  - Not always possible. What to do if we can't further pipeline a stage?
- Solution 2: Use multiple copies of the slow component

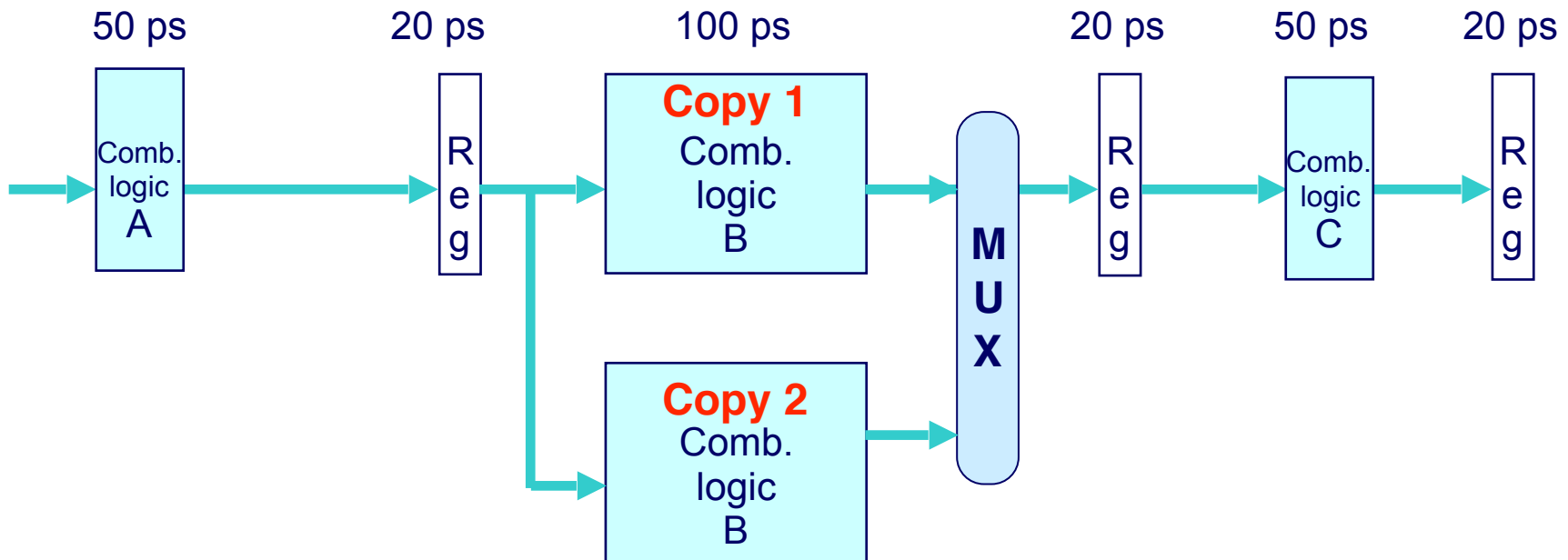

# Aside: Mitigating Unbalanced Pipeline

- Solution 1: Further pipeline the slow stages
  - Not always possible. What to do if we can't further pipeline a stage?
- Solution 2: Use multiple copies of the slow component

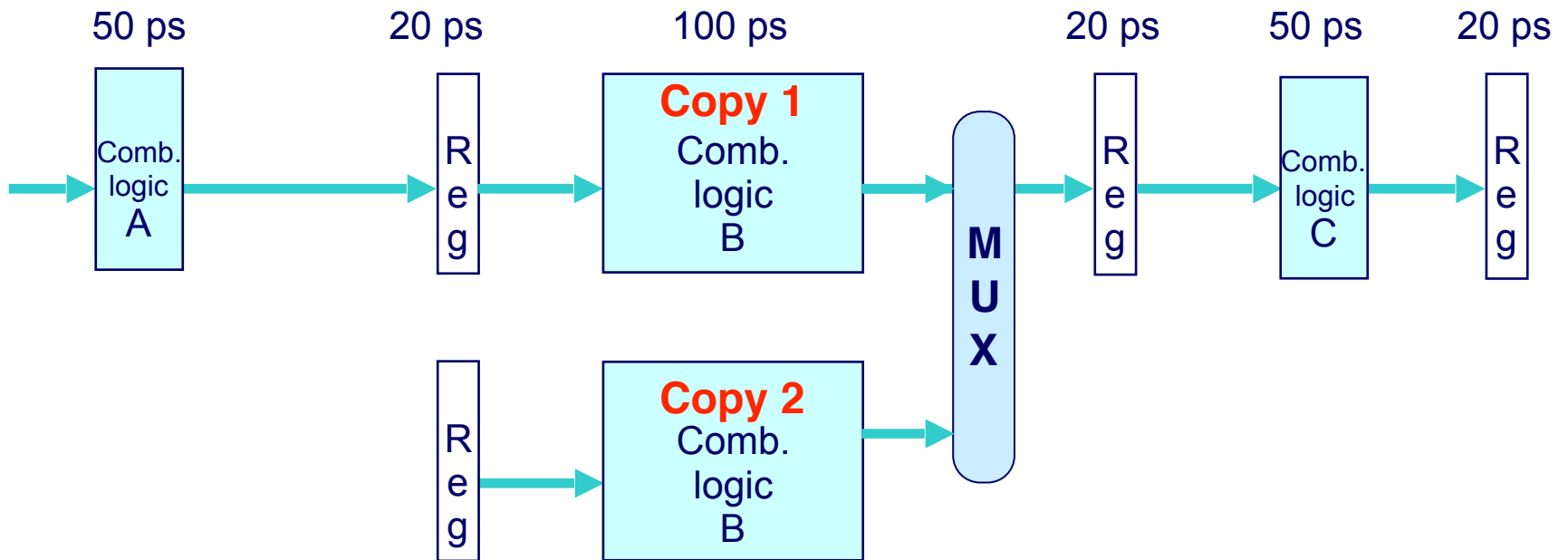

# Aside: Mitigating Unbalanced Pipeline

- Solution 1: Further pipeline the slow stages
  - Not always possible. What to do if we can't further pipeline a stage?
- Solution 2: Use multiple copies of the slow component

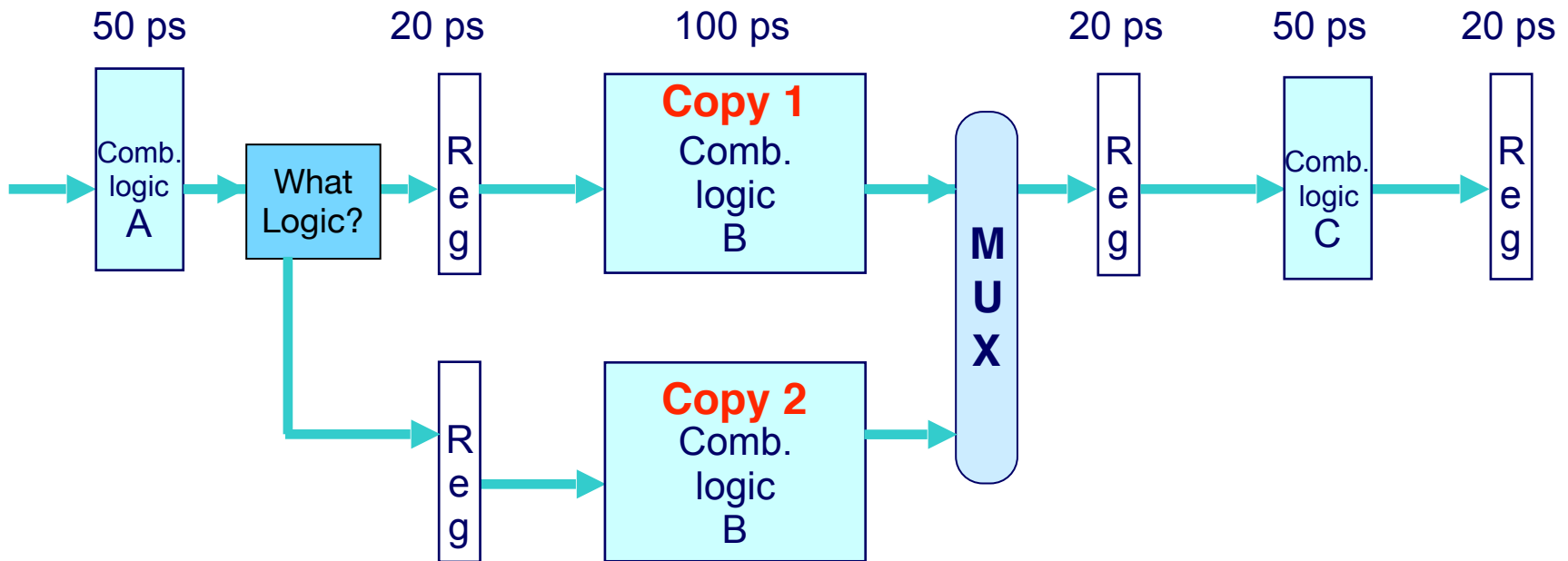

# Aside: Mitigating Unbalanced Pipeline

- Solution 1: Further pipeline the slow stages
  - Not always possible. What to do if we can't further pipeline a stage?
- Solution 2: Use multiple copies of the slow component

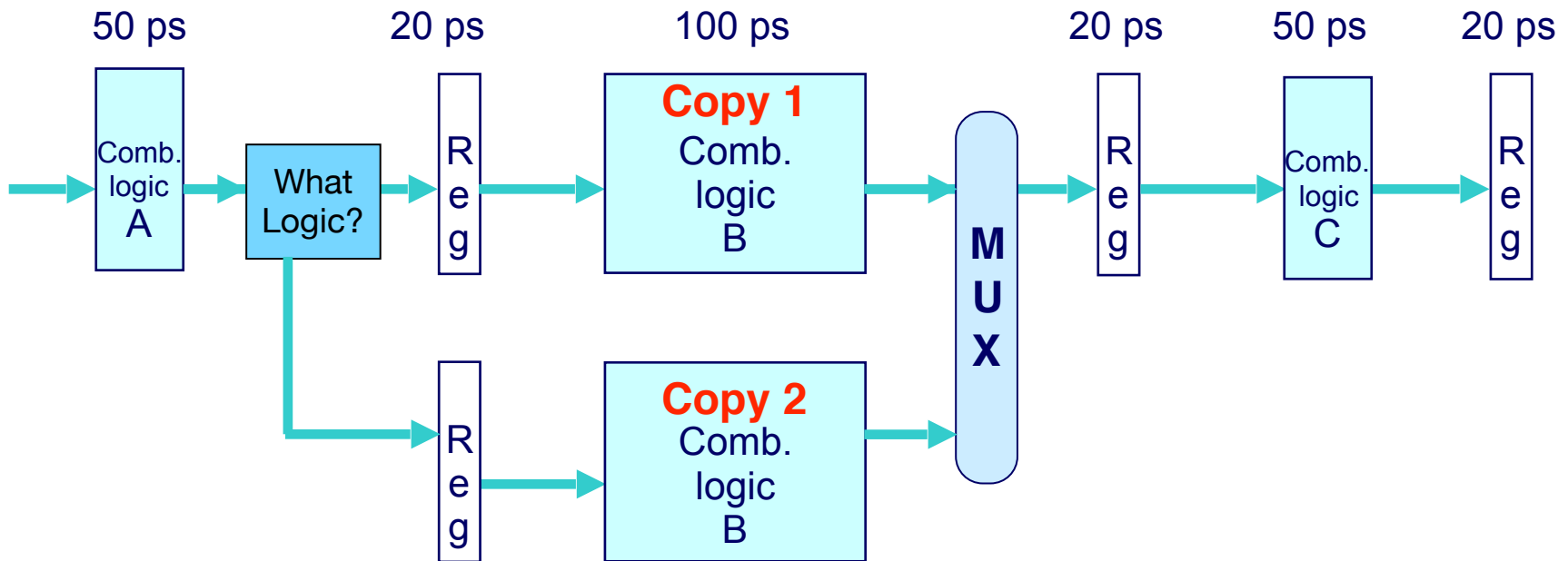

What logic do you need there?

Hint: it needs to control the clock signals of the two registers and the select signal of the MUX.

# Aside: Mitigating Unbalanced Pipeline

- Solution 1: Further pipeline the slow stages
  - Not always possible. What to do if we can't further pipeline a stage?
- Solution 2: Use multiple copies of the slow component

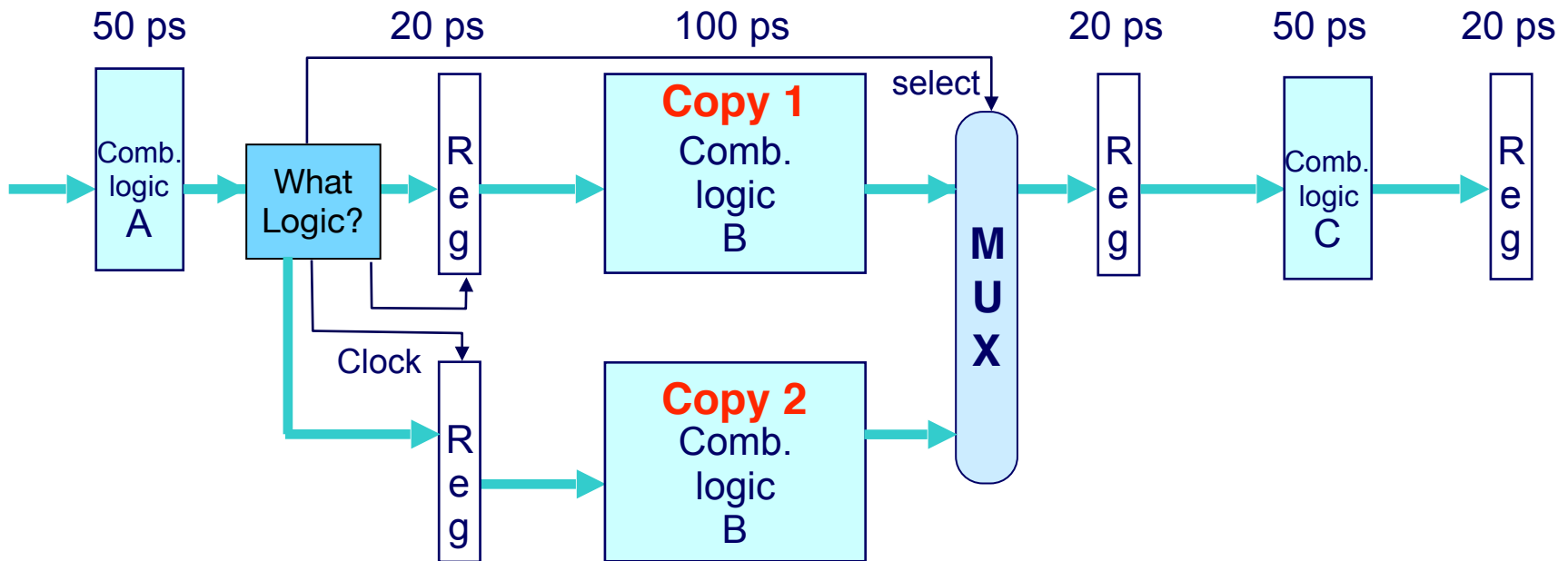

What logic do you need there?

Hint: it needs to control the clock signals of the two registers and the select signal of the MUX.

# Aside: Mitigating Unbalanced Pipeline

- Data sent to copy 1 in odd cycles and to copy 2 in even cycles.

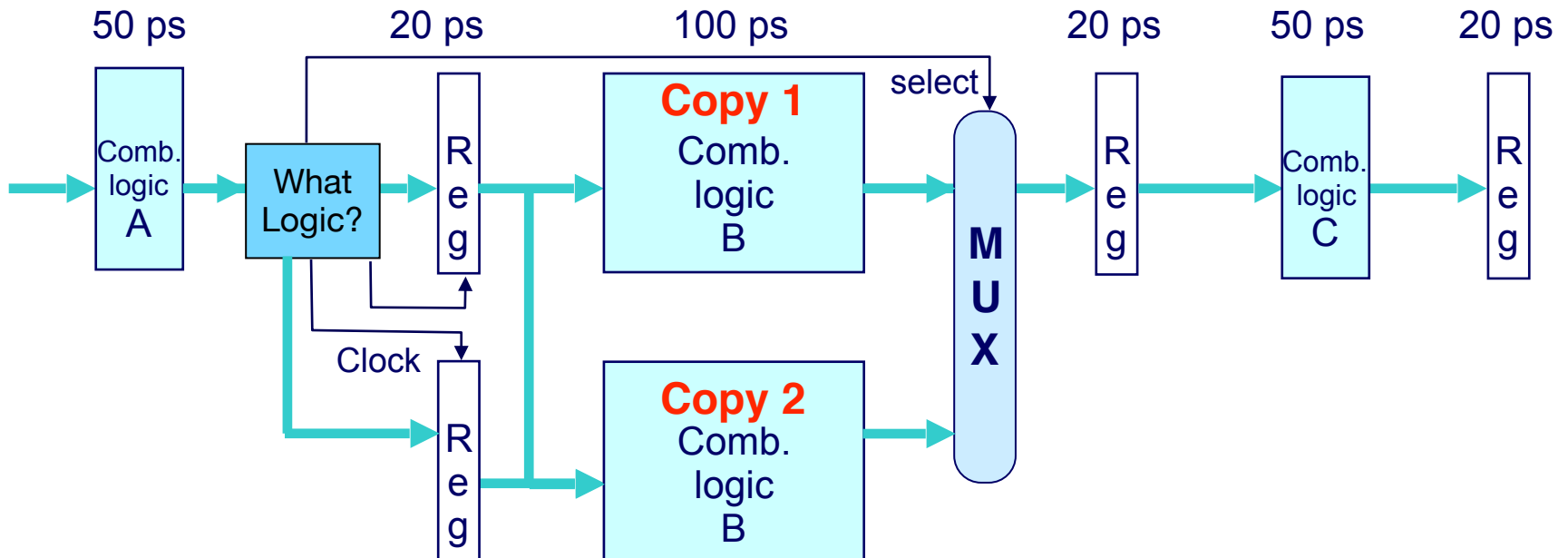



# Aside: Mitigating Unbalanced Pipeline

- Data sent to copy 1 in odd cycles and to copy 2 in even cycles.
- This is called 2-way interleaving. Effectively the same as pipelining Comb. logic B into two sub-stages.

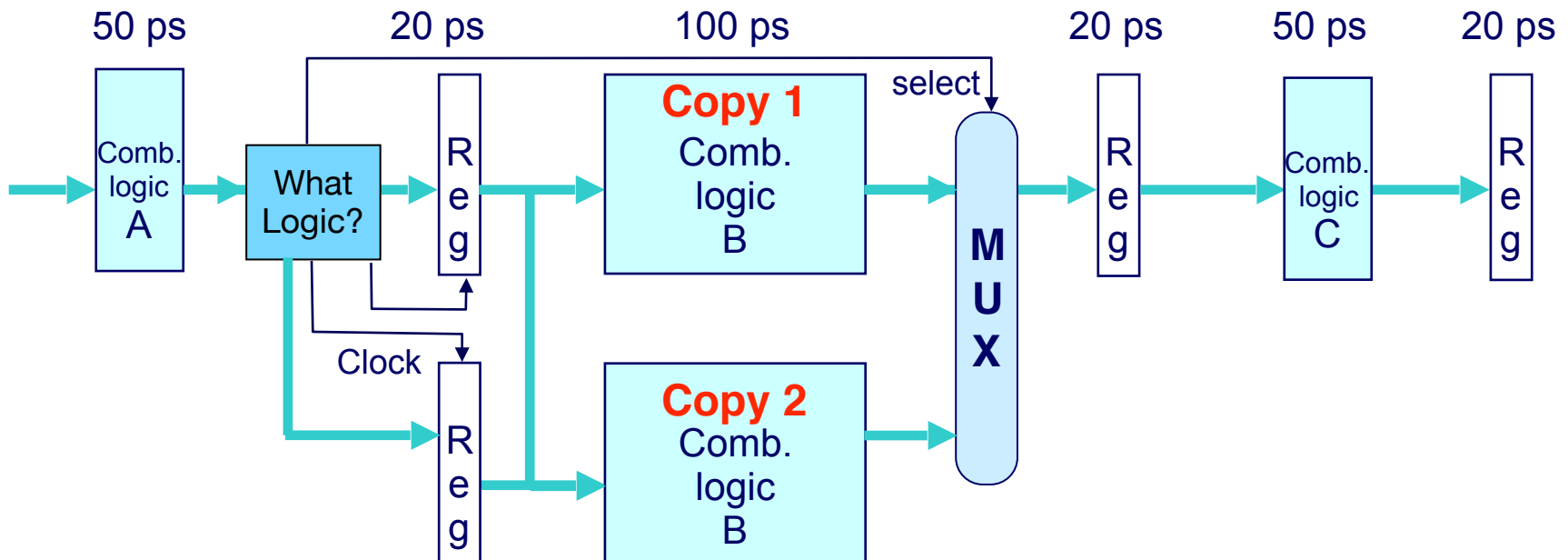

# Aside: Mitigating Unbalanced Pipeline

- Data sent to copy 1 in odd cycles and to copy 2 in even cycles.
- This is called 2-way interleaving. Effectively the same as pipelining Comb. logic B into two sub-stages.
- The cycle time is reduced to 70 ps (as opposed to 120 ps) at the cost of extra hardware.

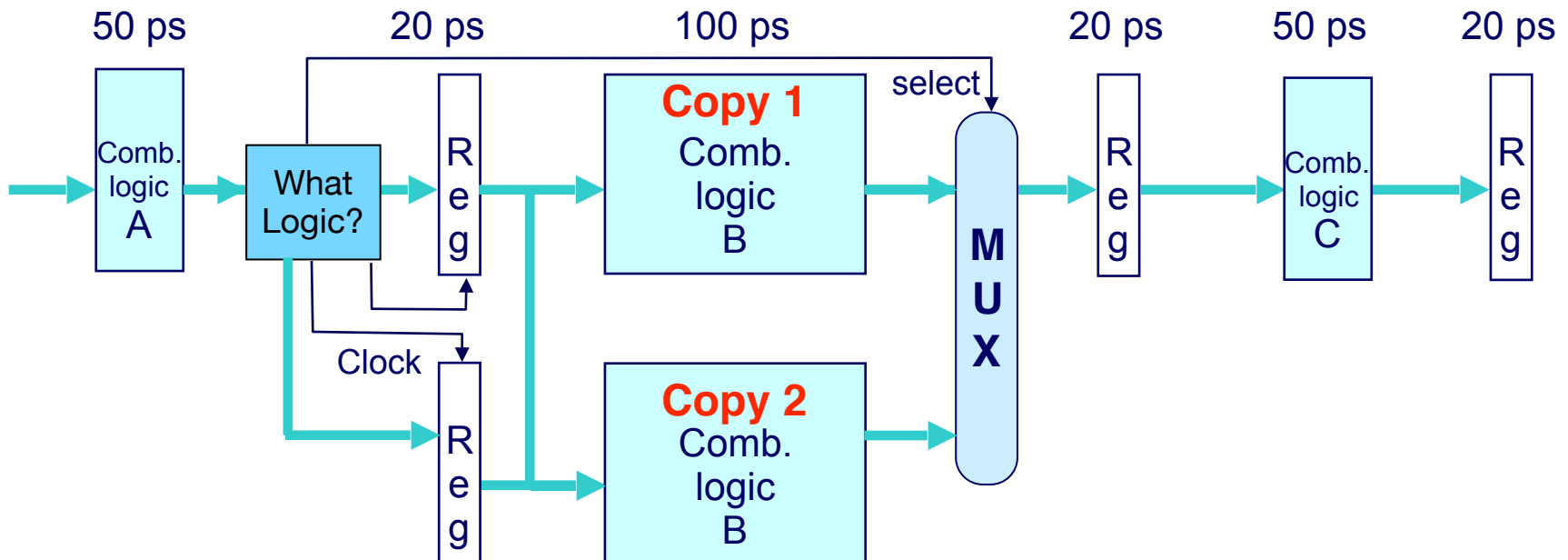

# Pipeline Stages

## Fetch

- Use PC to read instruction
- **Compute new PC for non-jump instructions**

## Decode

- Read program registers

## Execute

- Operate ALU
- **Compute new PC for jump instructions**

## Memory

- Read or write data memory

## Write Back

- Update register file

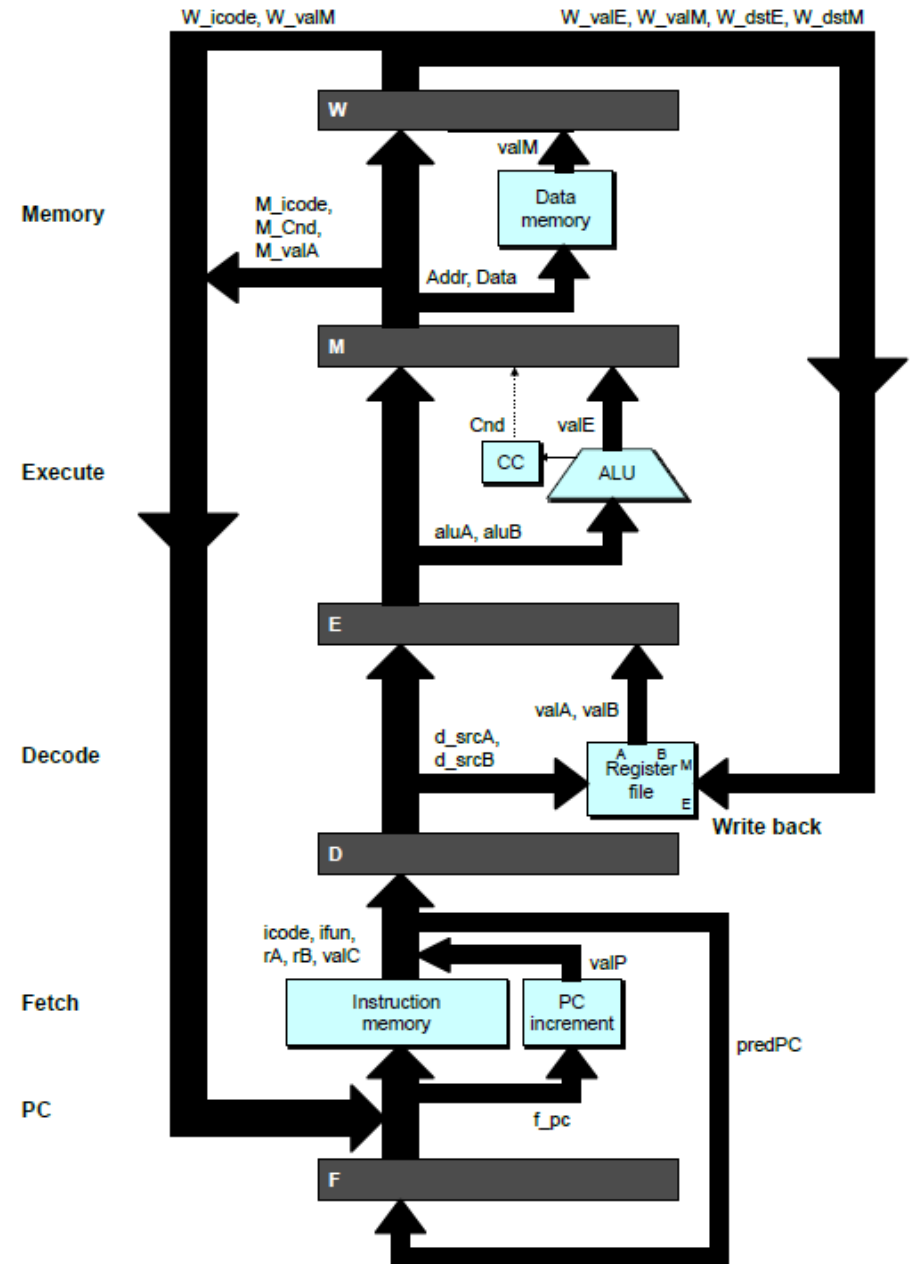

# Control Dependency

- **Definition:** Outcome of instruction A determines whether or not instruction B should be executed or not.
- Jump instruction example below:
  - `jne L1` determines whether `irmovq $1, %rax` should be executed
  - But `jne` doesn't know its outcome until after its Execute stage

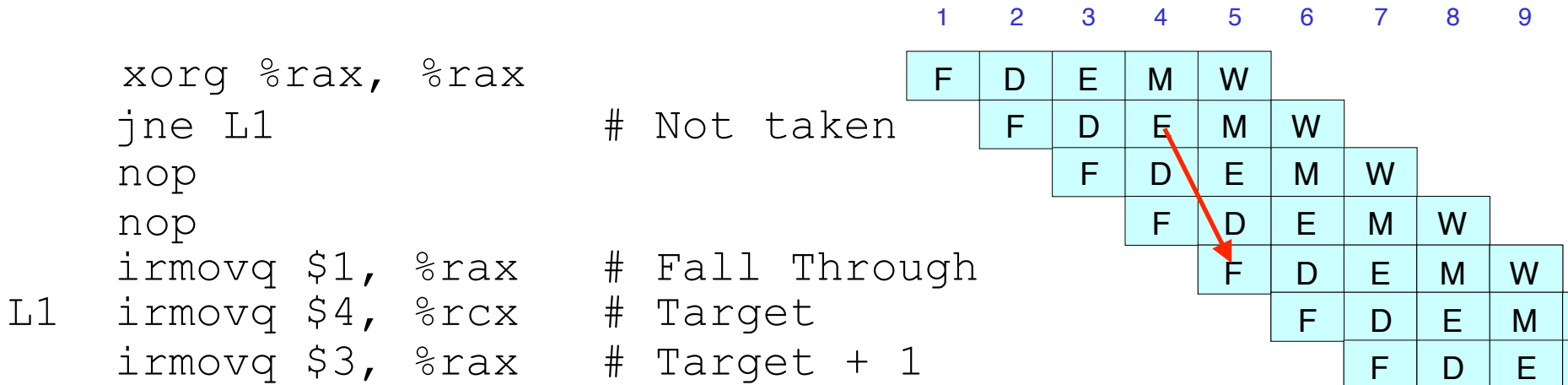

# Better Pipelining

## Fetch

- Use PC to read instruction
- **Compute new PC for non-jump instructions**

## Decode

- Read program registers
- **Compute new PC for jump instructions**

## Execute

- Operate ALU

## Memory

- Read or write data memory

## Write Back

- Update register file

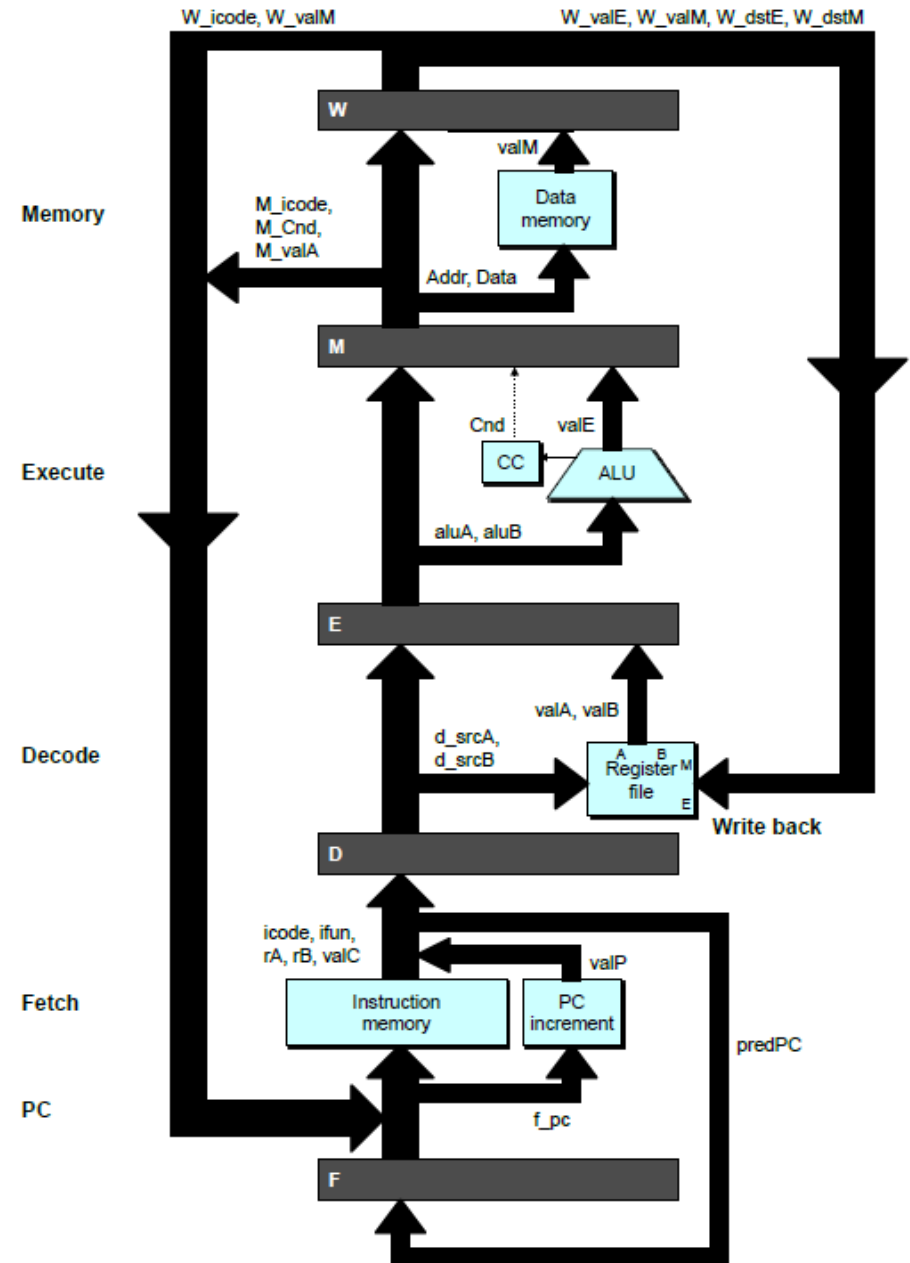

# Better Pipelining

## Fetch

- Use PC to read instruction
- **Compute new PC for non-jump instructions**

## Decode

- Read program registers
- **Compute new PC for jump instructions**

## Execute

- Operate ALU

## Memory

- Read or write data memory

## Write Back

- Update register file

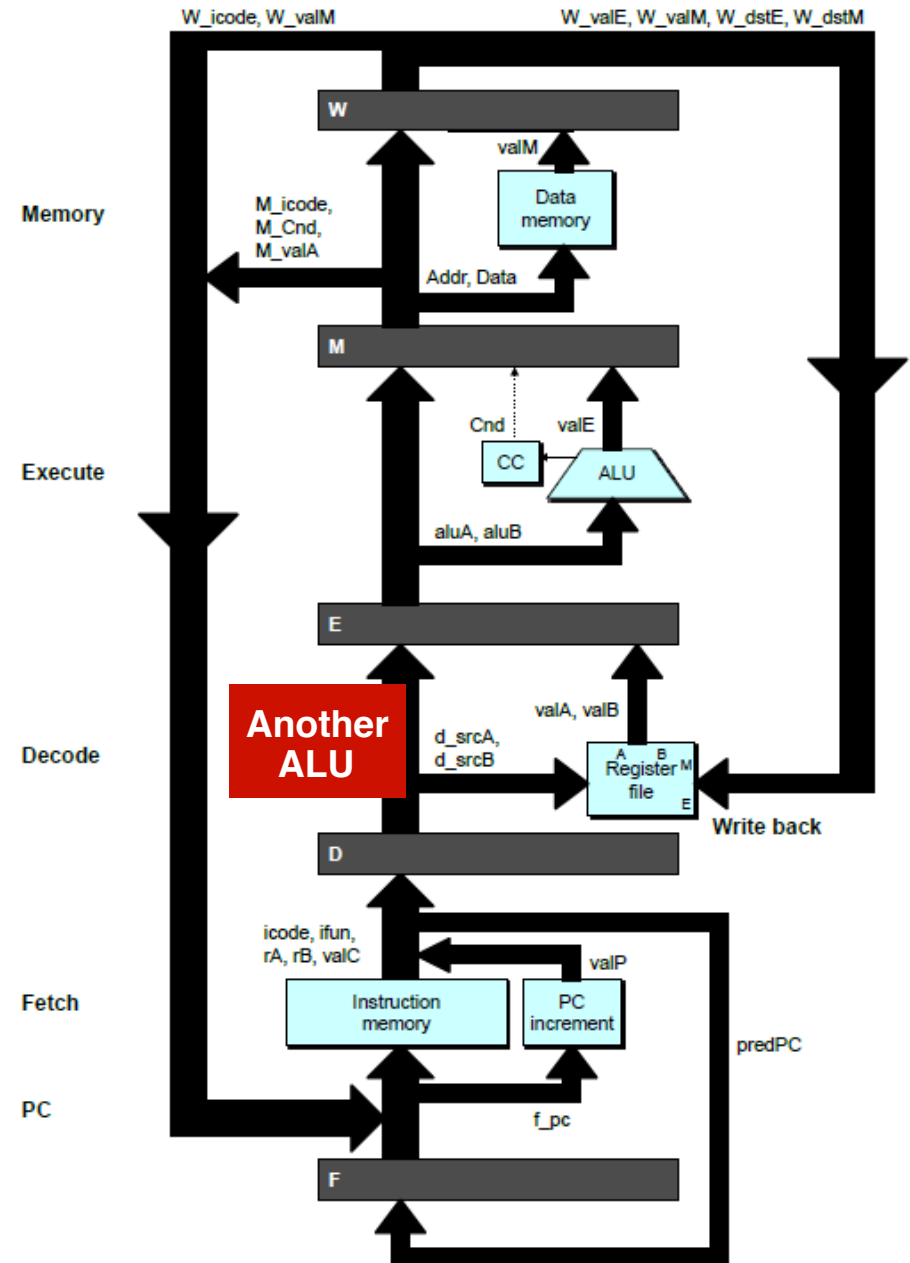

# Saving One Cycle

- **Definition:** Outcome of instruction A determines whether or not instruction B should be executed or not.
- Jump instruction example below:
  - `jne L1` determines whether `irmovq $1, %rax` should be executed
  - But `jne` doesn't know its outcome until after its Execute stage

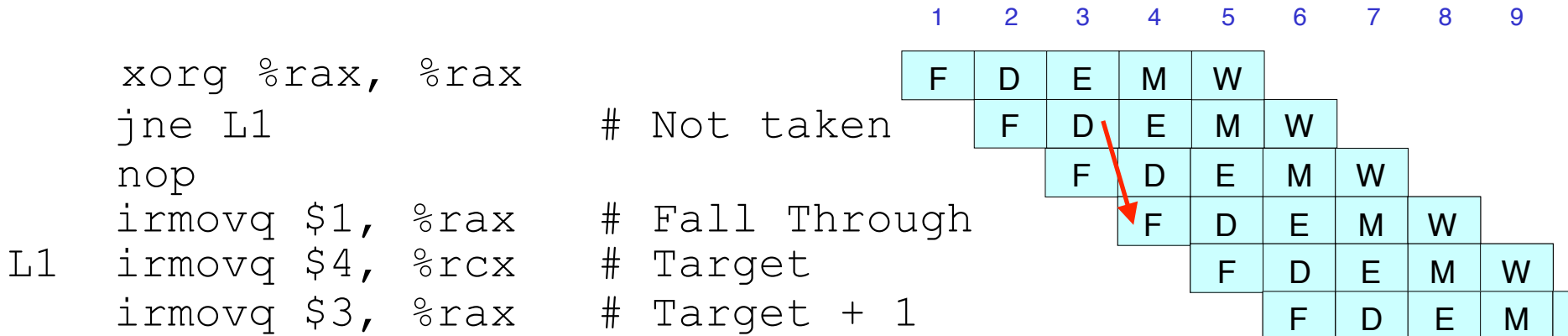

# Resolving Control Dependencies

- **Software Mechanisms**

- Adding NOPs: requires compiler to insert nops, which also take memory space — not a good idea
- Delay slot: insert instructions that do not depend on the effect of the preceding instruction. These instructions will execute even if the preceding branch is taken — old RISC approach

- **Hardware mechanisms**

- Stalling (Think of it as hardware automatically inserting nops)
- Branch Prediction
- Return Address Stack



# Branch Prediction

Idea: instead of waiting, why not just guess the direction of jump?

```
xorg %rax, %rax
jne L1 # Not taken
irmovq $1, %rax # Fall Through
L1: irmovq $4, %rcx # Target
    irmovq $3, %rax # Target + 1
```

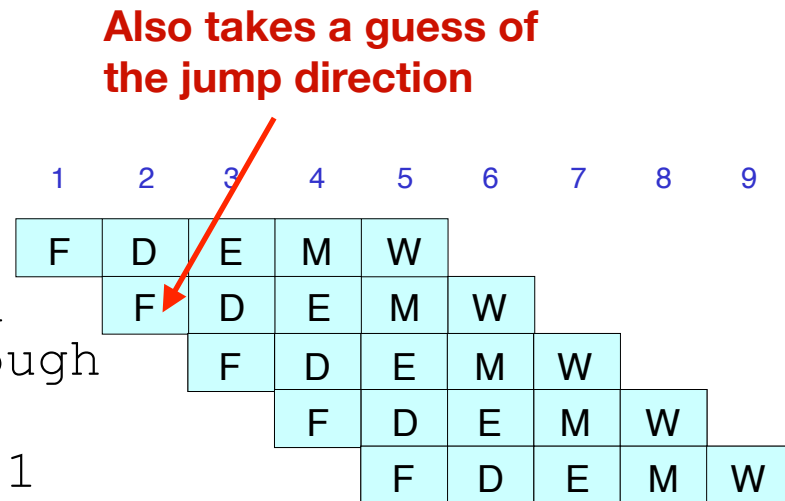

# Branch Prediction

Idea: instead of waiting, why not just guess the direction of jump?

If prediction is correct: pipeline moves forward without stalling

```
L1  xorg %rax, %rax
     jne L1          # Not taken
     irmovq $1, %rax # Fall Through
     irmovq $4, %rcx # Target
     irmovq $3, %rax # Target + 1
```

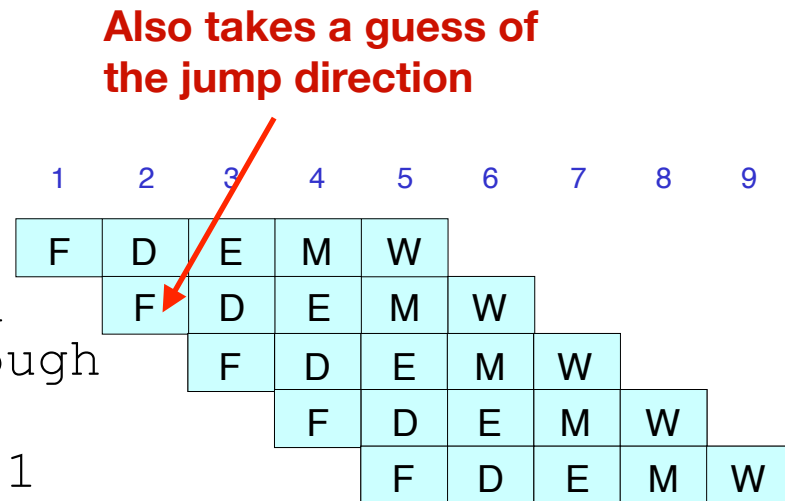

# Branch Prediction

Idea: instead of waiting, why not just guess the direction of jump?

If prediction is correct: pipeline moves forward without stalling

If mispredicted: kill mis-executed instructions, start from the correct target

```
xorg %rax, %rax
jne L1 # Not taken
irmovq $1, %rax # Fall Through
L1: irmovq $4, %rcx # Target
    irmovq $3, %rax # Target + 1
```

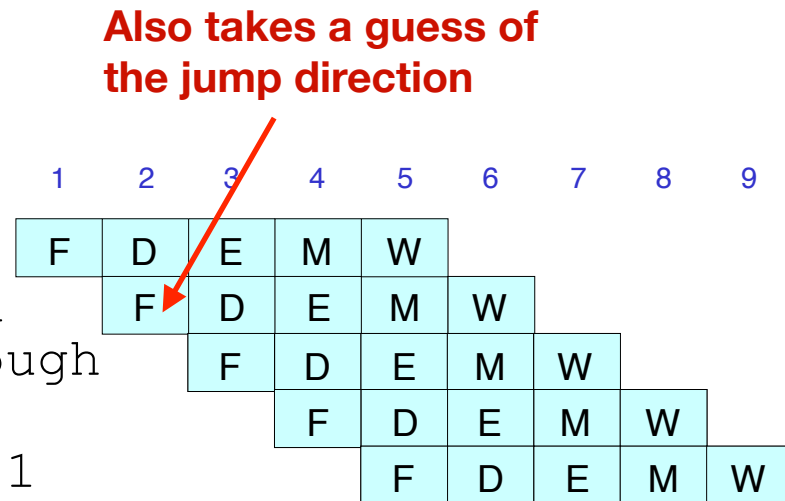

# Branch Prediction

Idea: instead of waiting, why not just guess the direction of jump?

If prediction is correct: pipeline moves forward without stalling

If mispredicted: kill mis-executed instructions, start from the correct target

## Static Prediction

- Always Taken
- Always Not-taken

## Dynamic Prediction

- Dynamically predict taken/not-taken for each specific jump instruction

# Static Prediction

# Static Prediction

Observation (Assumption really): Two uses of jumps

- People use jumps to check corner cases. These branches are mostly not taken because corner cases are rare.
- People use jumps to implement loops. These branches are mostly taken because a loop takes multiple iterations.

# Static Prediction

## Observation (Assumption really): Two uses of jumps

- People use jumps to check corner cases. These branches are mostly not taken because corner cases are rare.
- People use jumps to implement loops. These branches are mostly taken because a loop takes multiple iterations.

```
    cmpq    %rsi, %rdi
    jle    .corner_case
    <do_A>
.corner_case:
    <do_B>
    ret
```

# Static Prediction

## Observation (Assumption really): Two uses of jumps

- People use jumps to check corner cases. These branches are mostly not taken because corner cases are rare.
- People use jumps to implement loops. These branches are mostly taken because a loop takes multiple iterations.

```
cmpq    %rsi, %rdi
jle     .corner_case
<do_A>
.corner_case:
<do_B>
ret
```

 **Mostly not taken**



# Static Prediction

## Observation (Assumption really): Two uses of jumps

- People use jumps to check corner cases. These branches are mostly not taken because corner cases are rare.
- People use jumps to implement loops. These branches are mostly taken because a loop takes multiple iterations.

```
    cmpq    %rsi, %rdi           <before>
    jle    .corner_case        .L1: <body>
    <do_A>
    .corner_case:
    <do_B>
    ret
```

 **Mostly not taken**

```
    cmpq    B, A
    jl     .L1
    <after>
```

# Static Prediction

## Observation (Assumption really): Two uses of jumps

- People use jumps to check corner cases. These branches are mostly not taken because corner cases are rare.
- People use jumps to implement loops. These branches are mostly taken because a loop takes multiple iterations.

```
    cmpq    %rsi, %rdi
    jle    .corner_case
    <do_A>
.corner_case:
    <do_B>
    ret
```

 **Mostly not taken**

```
    <before>
.L1:  <body>
      cmpq  B, A
      jl   .L1
    <after>
```

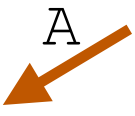
 **Mostly taken**

# Static Prediction

## Observation (Assumption really): Two uses of jumps

- People use jumps to check corner cases. These branches are mostly not taken because corner cases are rare.
- People use jumps to implement loops. These branches are mostly taken because a loop takes multiple iterations.

## Strategy:

- Forward jumps (i.e., `if-else`): always predict not-taken
- Backward jumps (i.e., `loop`): always predict taken

```
cmpq    %rsi, %rdi    <before>
jle     .corner_case  .L1: <body>
<do_A>
.corner_case:
<do_B>
ret
```

**Mostly not taken** (arrow pointing to `.corner_case`)

**Mostly taken** (arrow pointing to `jle .L1`)

# Static Prediction

Knowing branch prediction strategy helps us write faster code

- Any difference between the following two code snippets?
- What if you know that hardware uses the always non-taken branch prediction?

```
if (cond) {  
    do_A()  
} else {  
    do_B()  
}
```

```
if (!cond) {  
    do_B()  
} else {  
    do_A()  
}
```

# Dynamic Prediction

- Simplest idea:
  - If last time taken, predict taken; if last time not-taken, predict not-taken
  - Called 1-bit branch predictor
  - Works nicely for loops

# Dynamic Prediction

- Simplest idea:
  - If last time taken, predict taken; if last time not-taken, predict not-taken
  - Called 1-bit branch predictor
  - Works nicely for loops

```
for (i=0; i <5; i++) {...}
```

# Dynamic Prediction

- Simplest idea:
  - If last time taken, predict taken; if last time not-taken, predict not-taken
  - Called 1-bit branch predictor
  - Works nicely for loops

```
for (i=0; i <5; i++) {...}
```

Iteration #1	0	1	2	3	4
Predicted Outcome	<b>N</b>	T	T	T	<b>T</b>
Actual Outcome	T	T	T	T	N

# Dynamic Prediction

- Simplest idea:
  - If last time taken, predict taken; if last time not-taken, predict not-taken
  - Called 1-bit branch predictor
  - Works nicely for loops

```
for (i=0; i <5; i++) {...}
```

Iteration #1	0	1	2	3	4
Predicted Outcome	<b>N</b>	T	T	T	<b>T</b>
Actual Outcome	T	T	T	T	N





# Dynamic Prediction

- With 1-bit prediction, we change our mind instantly if mispredict
- Might be too quick. Thus 2-bit branch prediction: we have to mispredict *twice in a row* before changing our mind

# Dynamic Prediction

- With 1-bit prediction, we change our mind instantly if mispredict
- Might be too quick. Thus 2-bit branch prediction: we have to mispredict *twice in a row* before changing our mind

```
for (i=0; i <5; i++) {...}
```

Predict with 1-bit	<b>N</b>	T	T	T	<b>T</b>
Actual Outcome	T	T	T	T	N
Predict with 2-bit	<b>N</b>	<b>N</b>	T	T	<b>T</b>

# Dynamic Prediction

- With 1-bit prediction, we change our mind instantly if mispredict
- Might be too quick. Thus 2-bit branch prediction: we have to mispredict *twice in a row* before changing our mind

```
for (i=0; i <5; i++) {...}
```

Predict with 1-bit	<b>N</b>	T	T	T	<b>T</b>	<b>N</b>	T	T	T	<b>T</b>
Actual Outcome	T	T	T	T	N	T	T	T	T	N
Predict with 2-bit	<b>N</b>	<b>N</b>	T	T	<b>T</b>	T	T	T	T	<b>T</b>

# Dynamic Prediction

- With 1-bit prediction, we change our mind instantly if mispredict
- Might be too quick. Thus 2-bit branch prediction: we have to mispredict *twice in a row* before changing our mind

```
for (i=0; i <5; i++) {...}
```

Predict with 1-bit	N	T	T	T	T	N	T	T	T	T	N	T	T	T	T
Actual Outcome	T	T	T	T	N	T	T	T	T	N	T	T	T	T	N
Predict with 2-bit	N	N	T	T	T	T	T	T	T	T	T	T	T	T	T

# Dynamic Prediction

- With 1-bit prediction, we change our mind instantly if mispredict
- Might be too quick. Thus 2-bit branch prediction: we have to mispredict *twice in a row* before changing our mind

```
for (i=0; i <5; i++) {...}
```

Predict with 1-bit	N	T	T	T	T	N	T	T	T	T	N	T	T	T	T	N	T	T	T	T
Actual Outcome	T	T	T	T	N	T	T	T	T	N	T	T	T	T	N	T	T	T	T	N
Predict with 2-bit	N	N	T	T	T	T	T	T	T	T	T	T	T	T	T	T	T	T	T	T

# More Advanced Dynamic Prediction

- Look for past histories *across instructions*
- Branches are often correlated
  - Direction of one branch determines another

cond1 branch not-  
taken means  $(x \leq 0)$   
branch taken

```
x = 0
if (cond1) x = 3
if (cond2) y = 19
if (x <= 0) z = 13
```

# What Happens If We Mispredict?

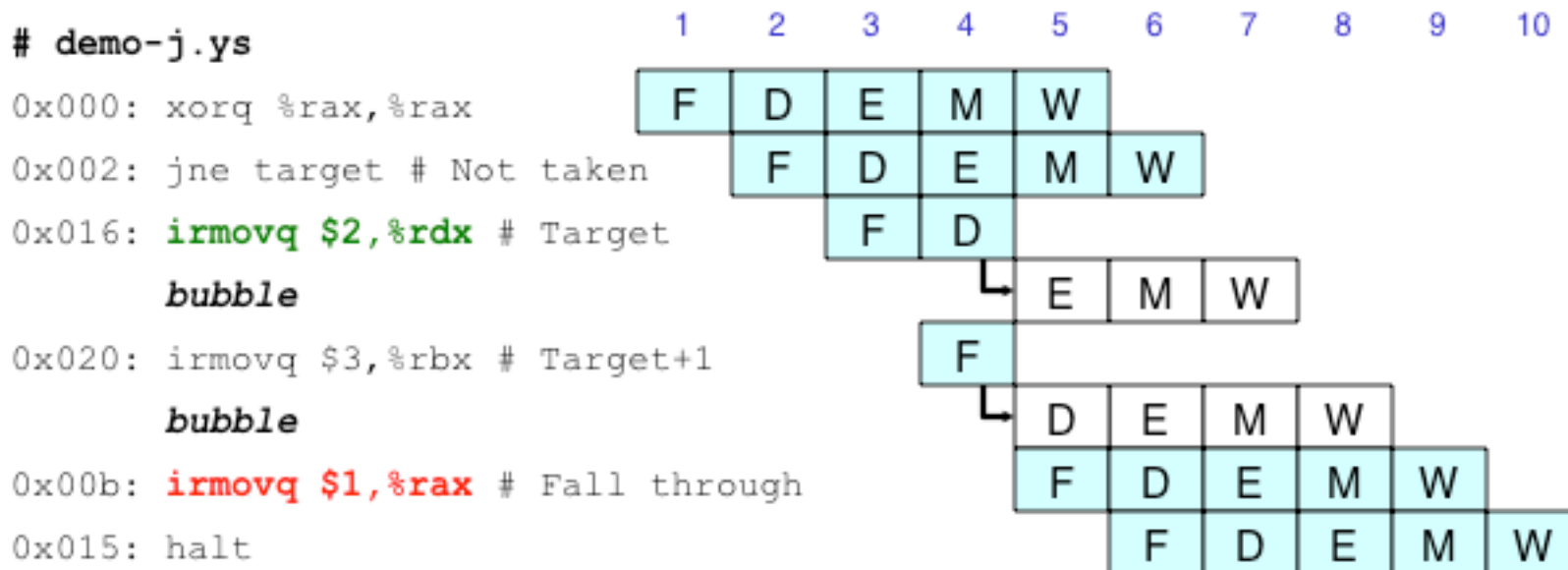

## Cancel instructions when mispredicted

- Assuming we detect branch not-taken in execute stage
- On following cycle, replace instructions in execute and decode by **bubbles**
- No side effects have occurred yet

# Today: Making the Pipeline Really Work

- Control Dependencies

- Inserting Nops
- Stalling
- Delay Slots
- Branch Prediction

- Data Dependencies

- Inserting Nops
- Stalling
- Out-of-order execution



# Data Dependencies

```
1    irmovq $50, %rax
2    addq   %rax, %rbx
3    mrmovq 100(%rbx), %rdx
```

# Data Dependencies

```
1    irmovq $50, %rax
2    addq   %rax, %rbx
3    mrmovq 100(%rbx), %rdx
```



# Data Dependencies

```
1    irmovq $50, %rax
2    addq   %rax, %rbx
3    mrmovq 100(%rbx), %rdx
```

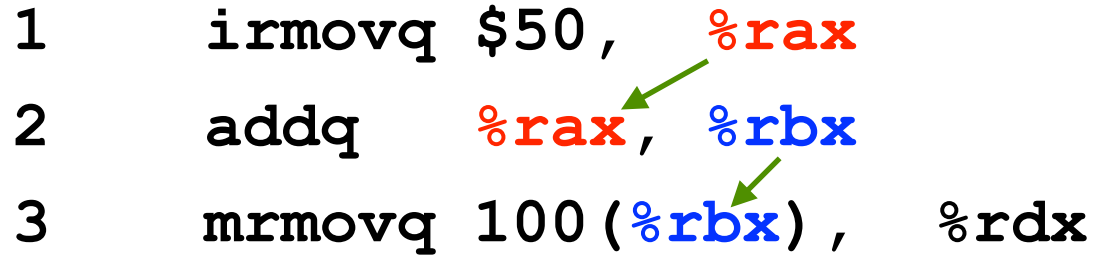

# Data Dependencies

```
1    irmovq $50, %rax
2    addq   %rax, %rbx
3    mrmovq 100(%rbx), %rdx
```

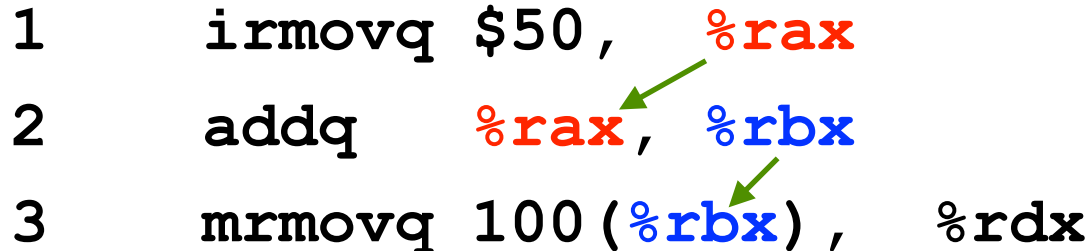

- Result from one instruction used as operand for another
  - **Read-after-write (RAW)** dependency
- Very common in actual programs
- Must make sure our pipeline handles these properly
  - Get correct results
  - Minimize performance impact

# A Subtle Data Dependency

- Jump instruction example below:
  - `jne L1` determines whether `irmovq $1, %rax` should be executed
  - But `jne` doesn't know its outcome **until after its Execute stage.**

**Why?**

```
xorg %rax, %rax
jne L1           # Not taken
irmovq $1, %rax # Fall Through
L1  irmovq $4, %rcx # Target
    irmovq $3, %rax # Target + 1
```

# A Subtle Data Dependency

- Jump instruction example below:
  - `jne L1` determines whether `irmovq $1, %rax` should be executed
  - But `jne` doesn't know its outcome **until after its Execute stage.**

## Why?

- There is a data dependency between `xorg` and `jne`. The “data” is the status flags.

```
xorg %rax, %rax
jne L1           # Not taken
irmovq $1, %rax # Fall Through
L1  irmovq $4, %rcx # Target
    irmovq $3, %rax # Target + 1
```

# Data Dependencies in Single-Cycle Machines

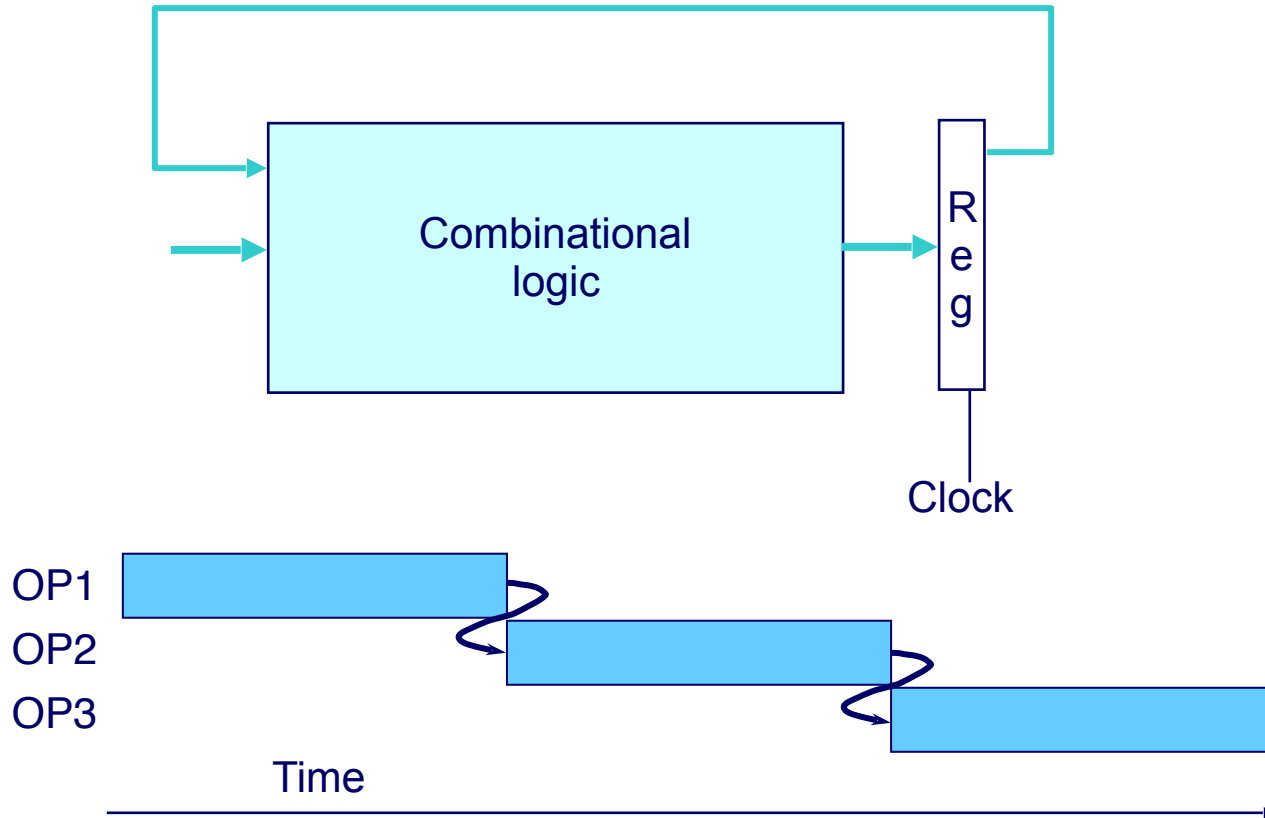

## In Single-Cycle Implementation:

- Each operation starts only after the previous operation finishes. Dependency always satisfied.

# Data Dependencies in Pipeline Machines

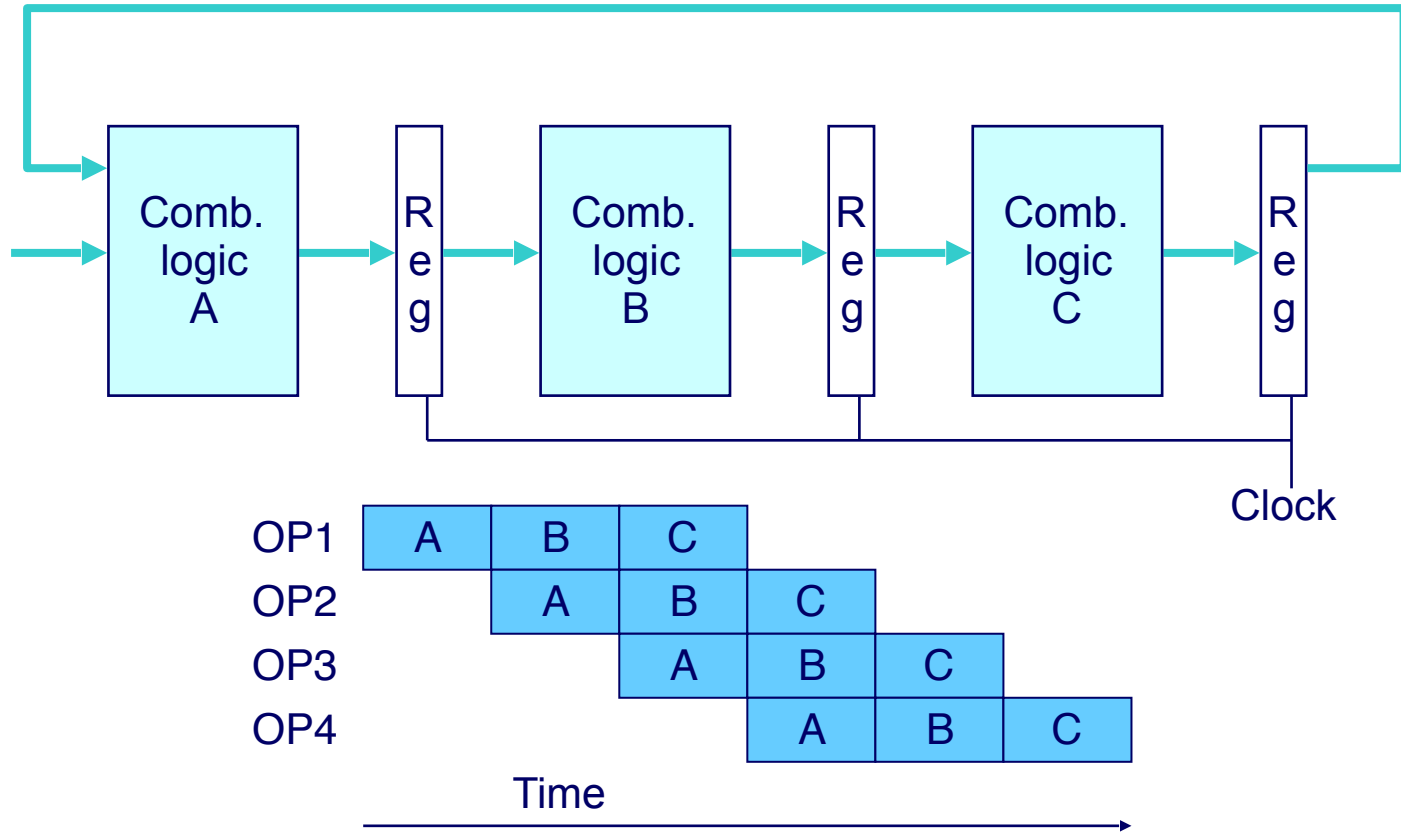

Data Hazards happen when:

- Result does not feed back around in time for next operation



# Data Dependencies in Pipeline Machines

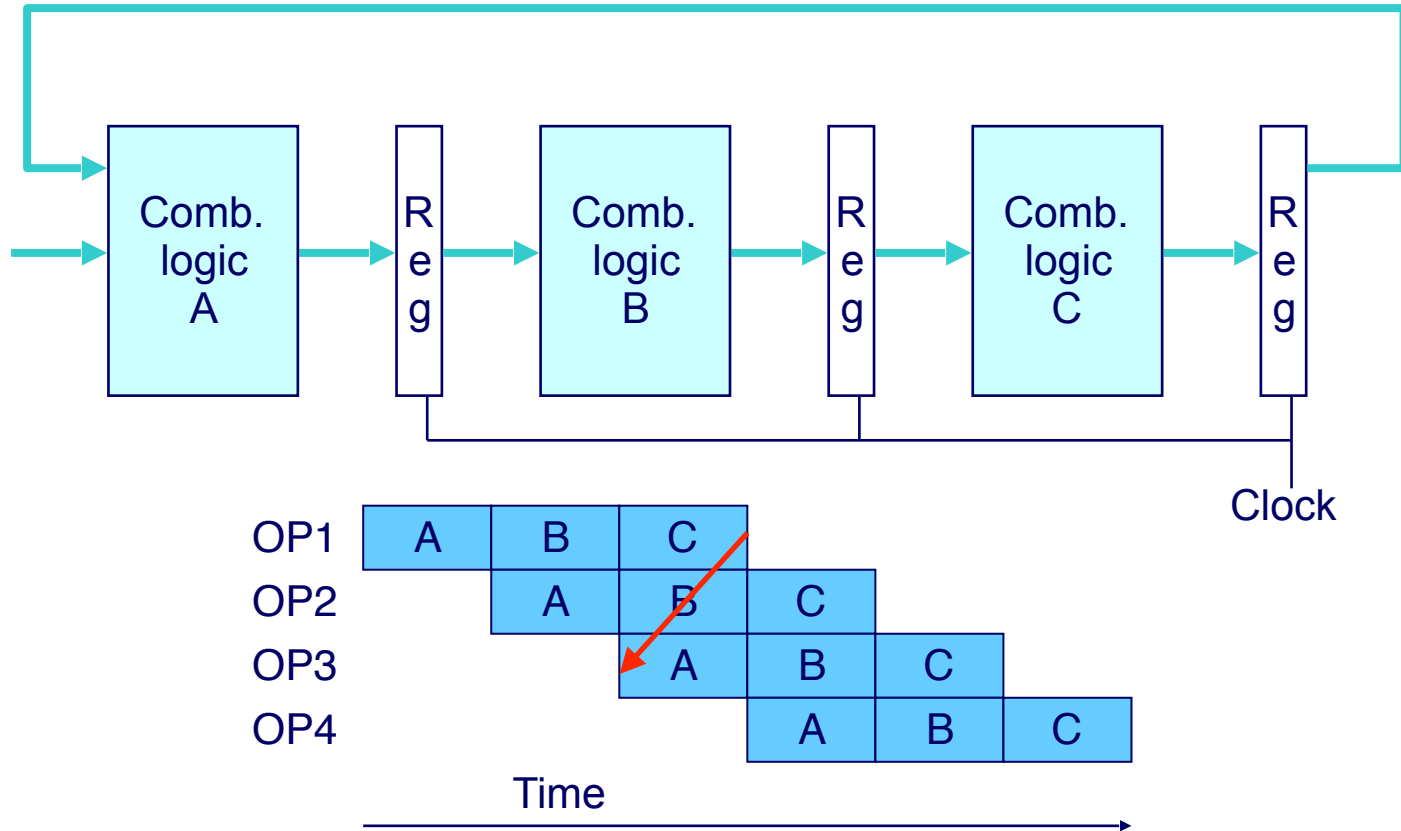

Data Hazards happen when:

- Result does not feed back around in time for next operation

# Data Dependencies: No Nop

0x000: `irmovq $10,%rdx`

0x00a: `irmovq $3,%rax`

0x014: `addq %rdx,%rax`

0x016: `halt`

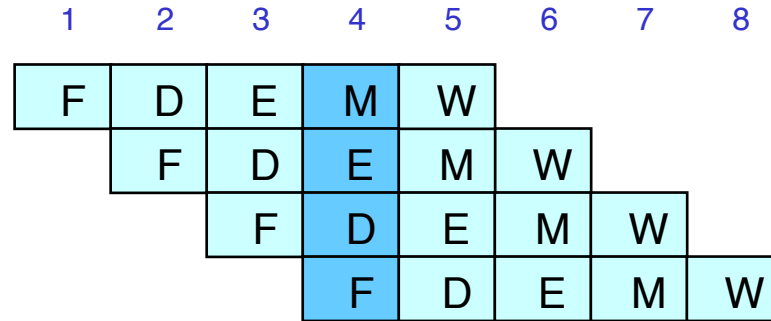

Remember registers get updated in the Write-back stage

# Data Dependencies: No Nop

0x000: `irmovq $10,%rdx`

0x00a: `irmovq $3,%rax`

0x014: `addq %rdx,%rax`

0x016: `halt`

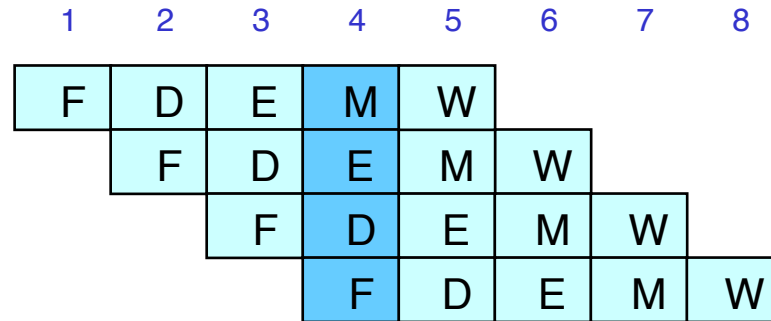

Remember registers get updated in the Write-back stage

**addq reads wrong %rdx and %rax**

# Data Dependencies: 1 Nop

```
0x000: irmovq $10,%rdx
0x00a: irmovq $3,%rax
0x014: nop
0x015: addq %rdx,%rax
0x017: halt
```

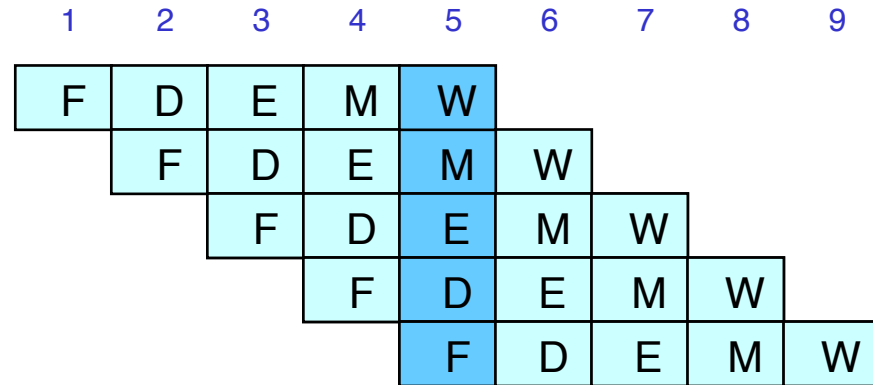

**addq still reads wrong %rdx and %rax**

# Data Dependencies: 2 Nop's

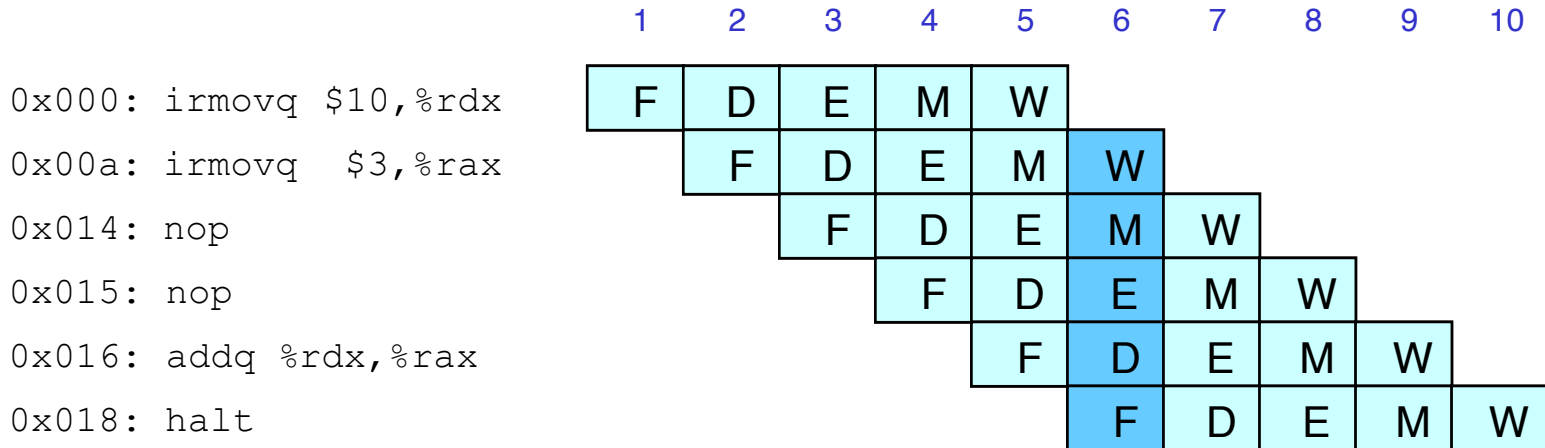

**addq reads the correct %rdx,  
but %rax still wrong**

# Data Dependencies: 3 Nop's

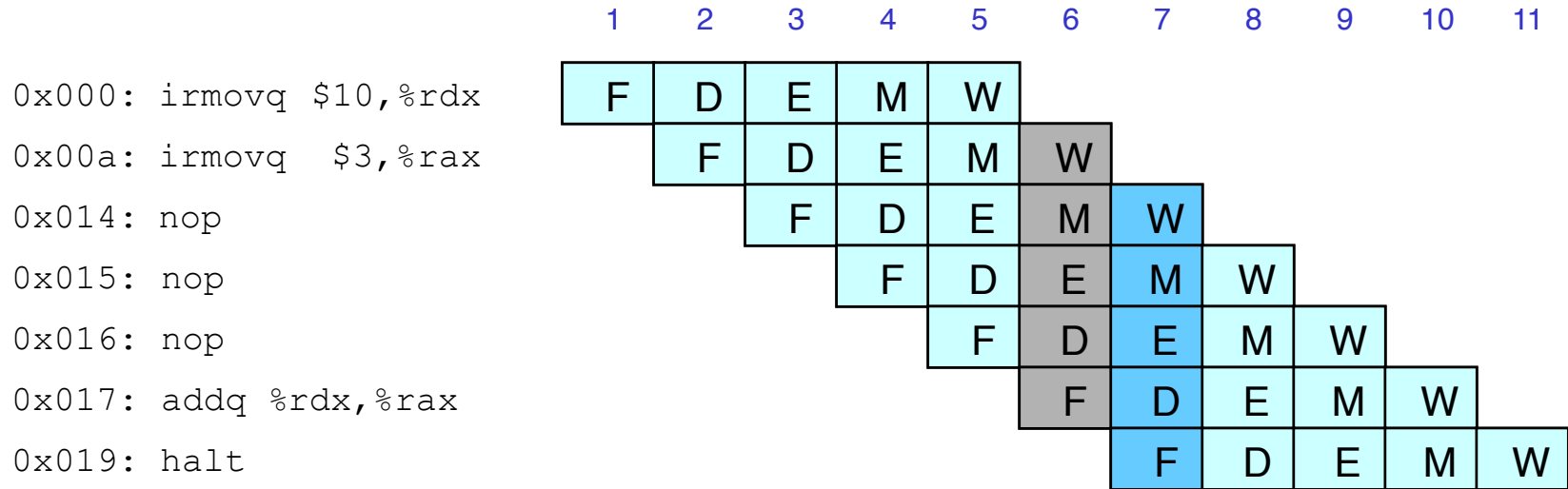

**addq reads the correct %rdx  
and %rax**

# Hardware Generated Nops (Bubble and Stalling)

Can we have the hardware automatically generates a nop?

- Why is it good for the hardware to do so anyways?

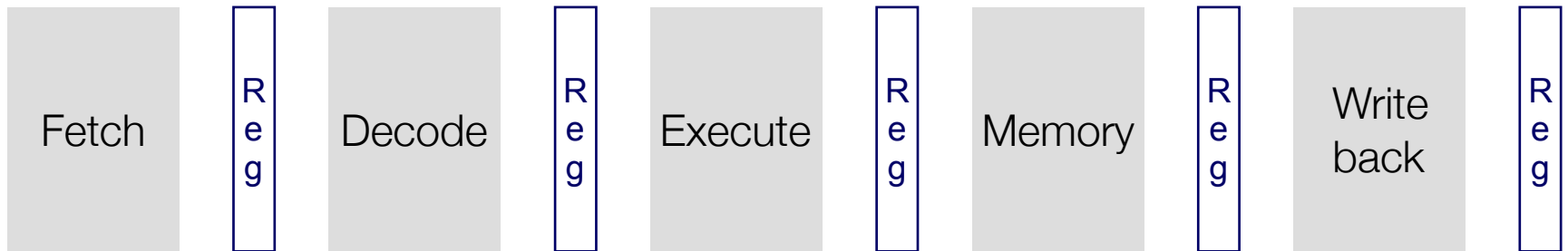

# Hardware Generated Nops (Bubble and Stalling)

Can we have the hardware automatically generates a nop?

- Why is it good for the hardware to do so anyways?

**Inst0**

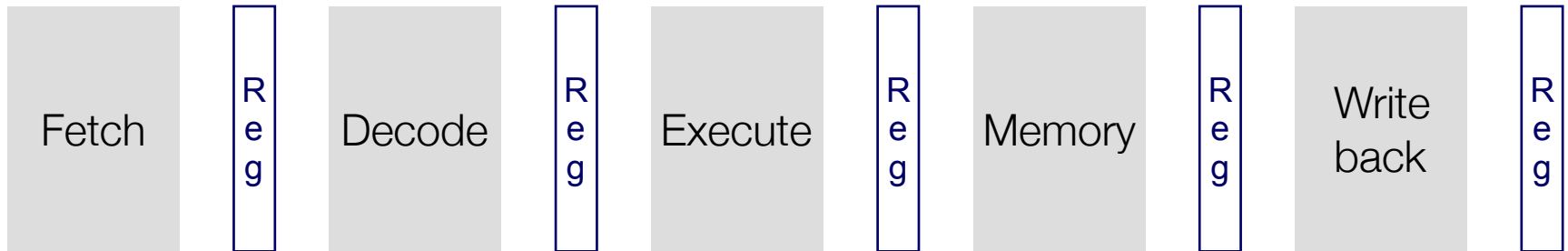



# Hardware Generated Nops (Bubble and Stalling)

Can we have the hardware automatically generates a nop?

- Why is it good for the hardware to do so anyways?

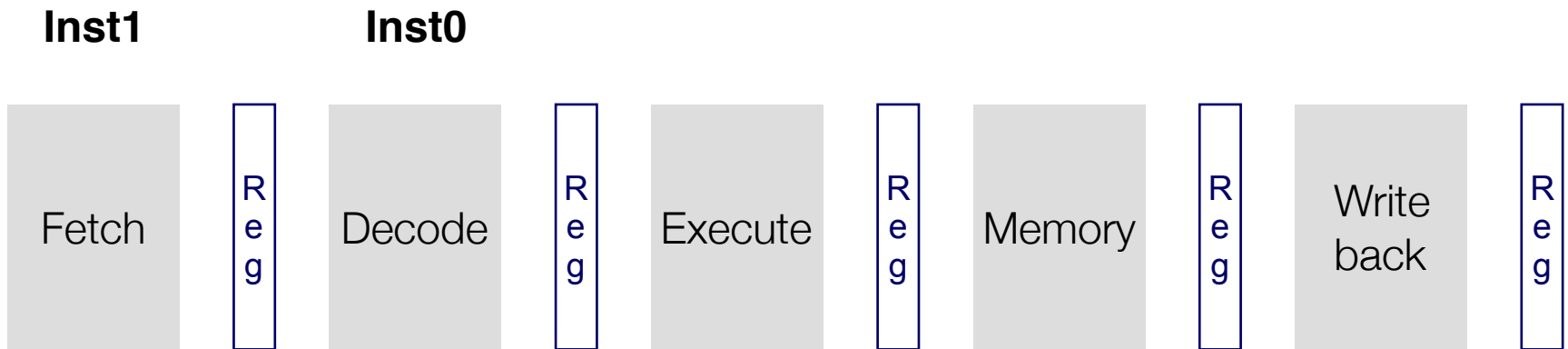

# Hardware Generated Nops (Bubble and Stalling)

Can we have the hardware automatically generates a nop?

- Why is it good for the hardware to do so anyways?

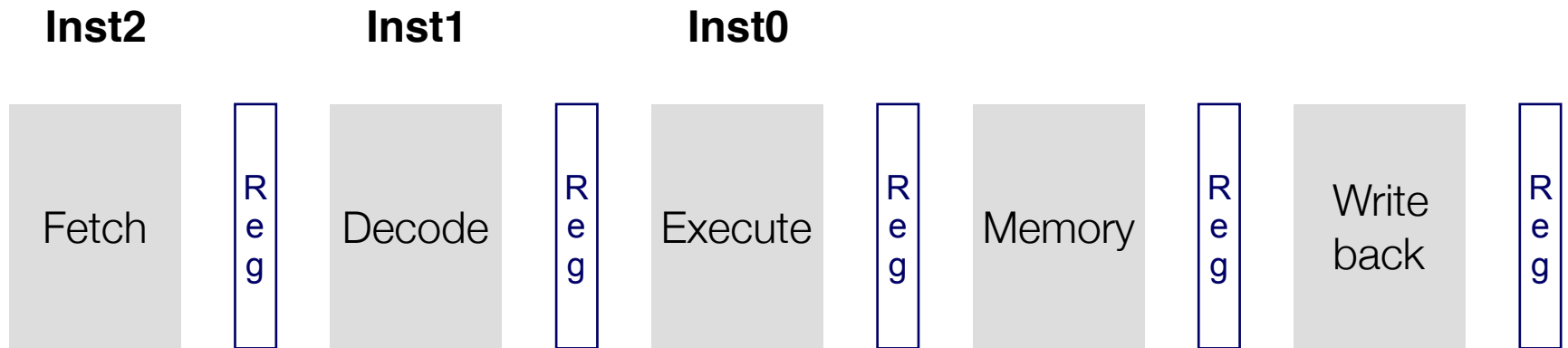

# Hardware Generated Nops (Bubble and Stalling)

Can we have the hardware automatically generates a nop?

- Why is it good for the hardware to do so anyways?

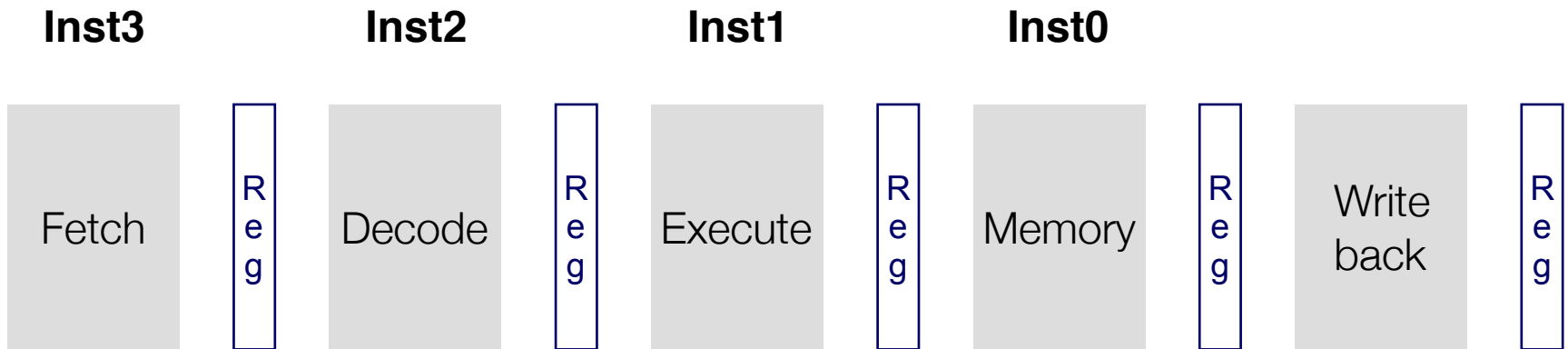

# Hardware Generated Nops (Bubble and Stalling)

Can we have the hardware automatically generates a nop?

- Why is it good for the hardware to do so anyways?

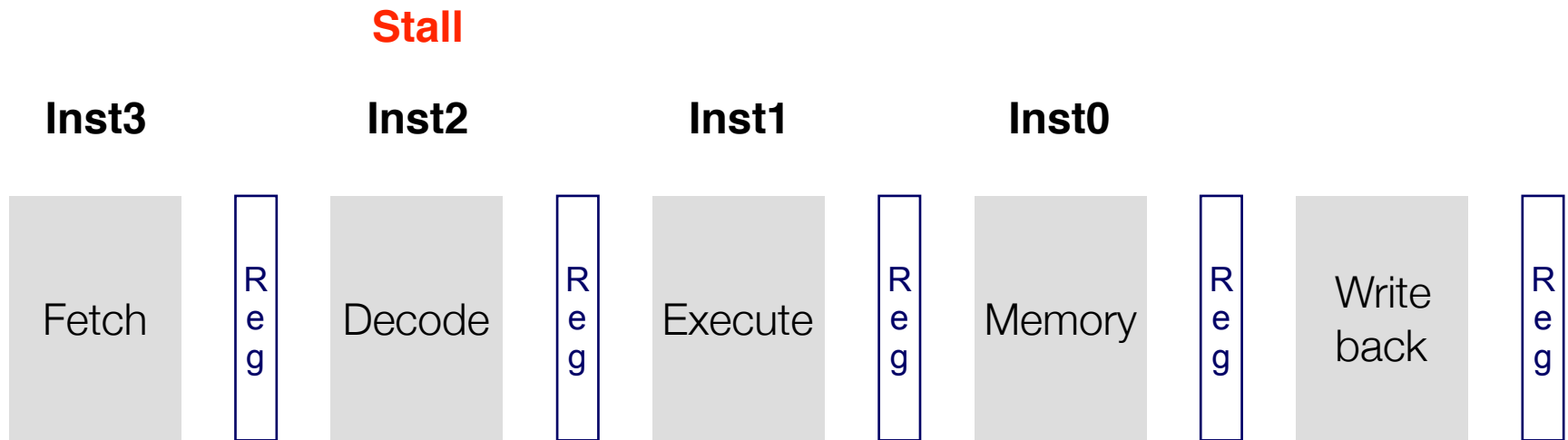

# Hardware Generated Nops (Bubble and Stalling)

Can we have the hardware automatically generates a nop?

- Why is it good for the hardware to do so anyways?

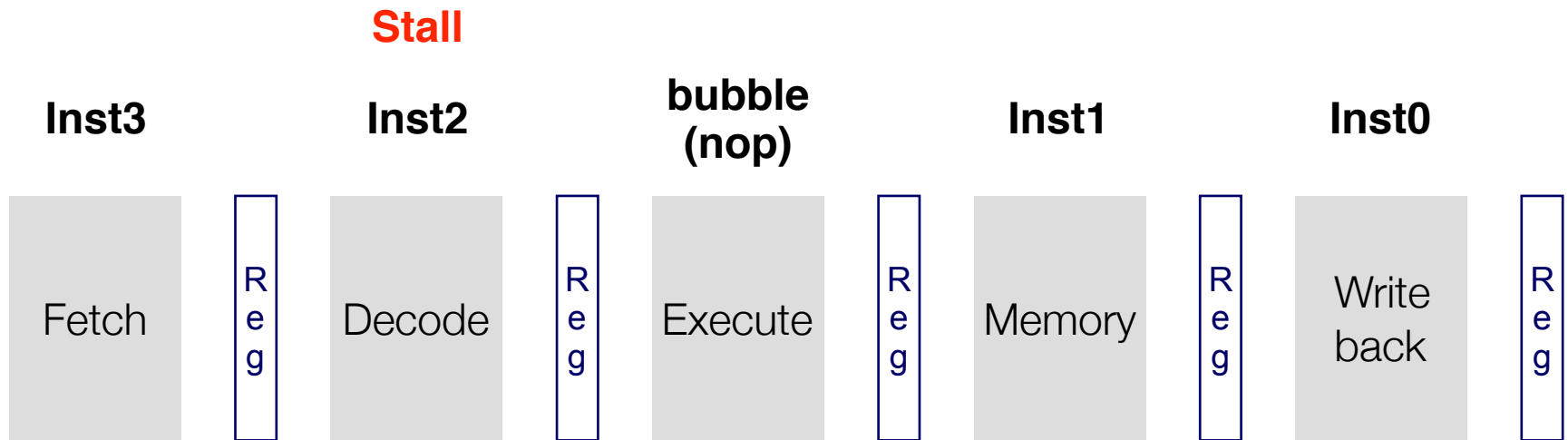

# Hardware Generated Nops (Bubble and Stalling)

Can we have the hardware automatically generates a nop?

- Why is it good for the hardware to do so anyways?

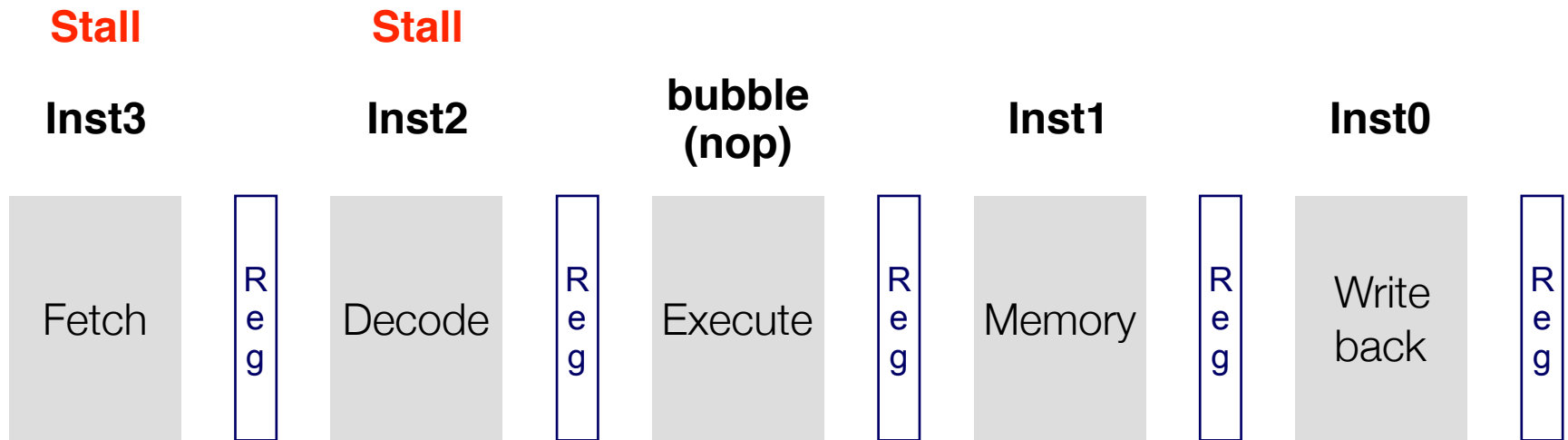

# Hardware Generated Nops (Bubble and Stalling)

Can we have the hardware automatically generates a nop?

- Why is it good for the hardware to do so anyways?

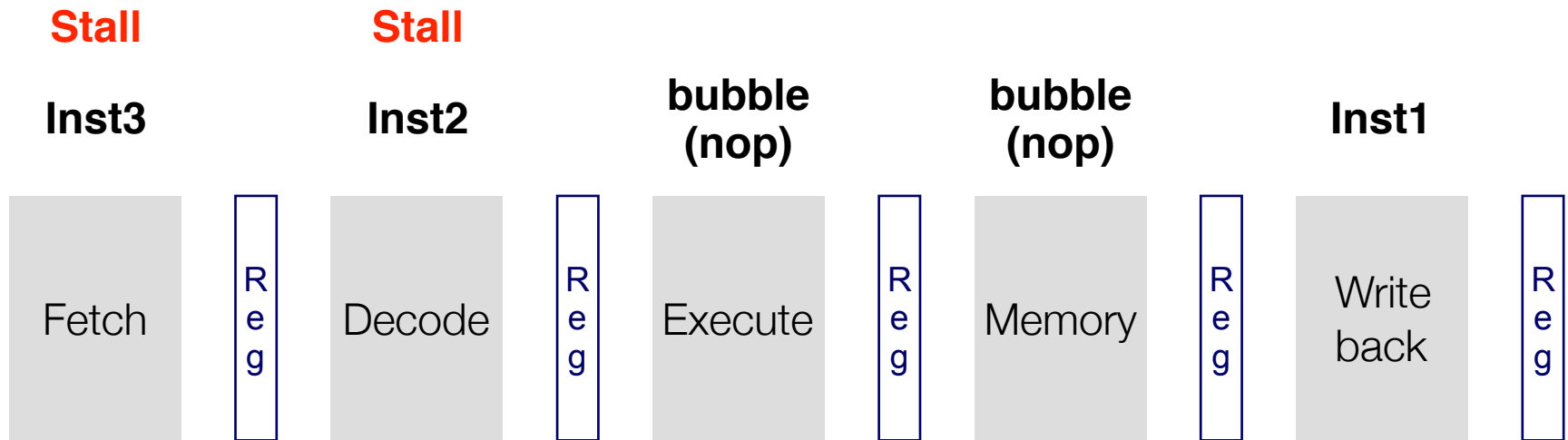

# Hardware Generated Nops (Bubble and Stalling)

Can we have the hardware automatically generates a nop?

- Why is it good for the hardware to do so anyways?

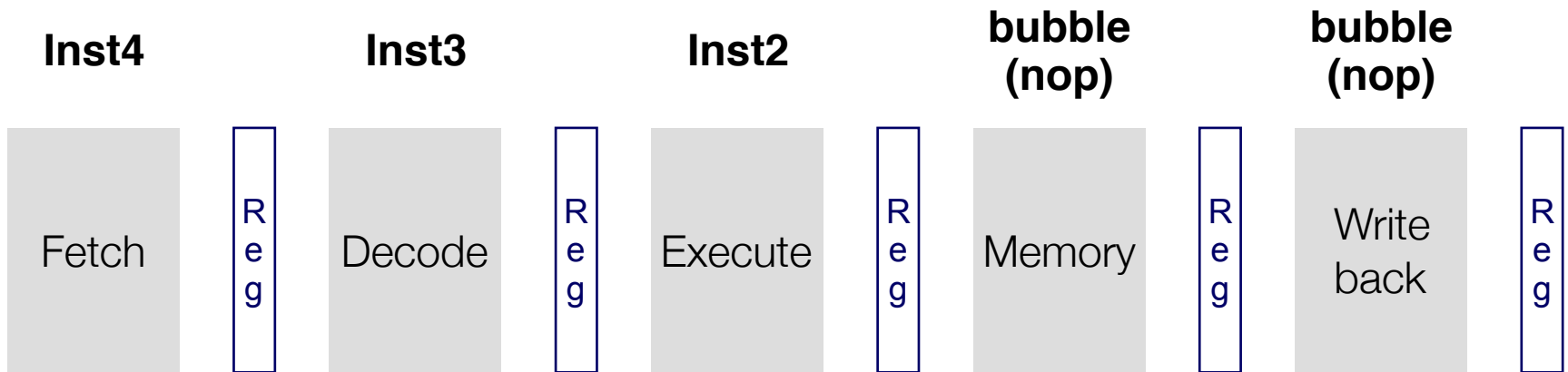



# Hardware Generated Nops (Bubble and Stalling)

Can we have the hardware automatically generates a nop?

- Why is it good for the hardware to do so anyways?

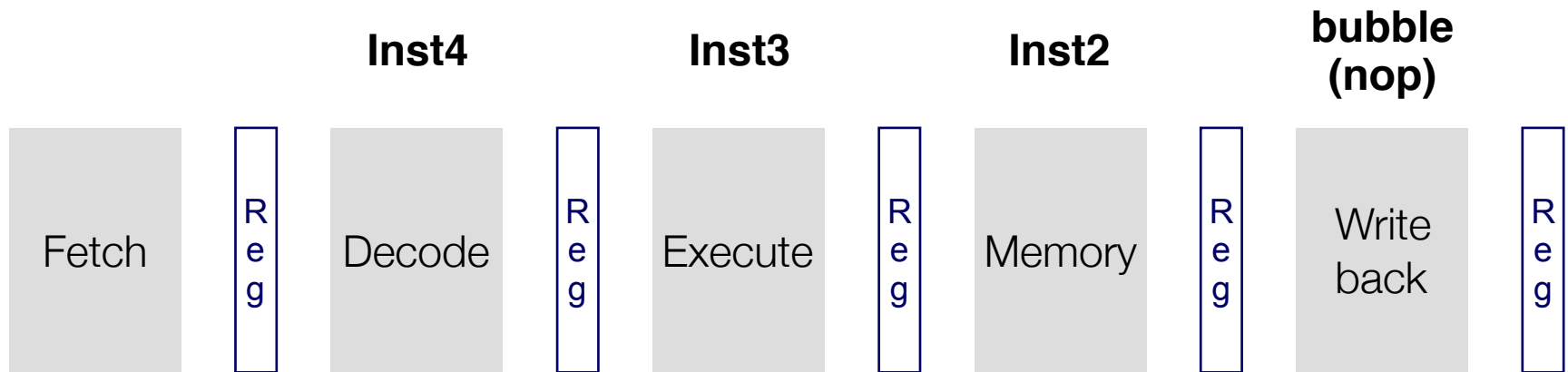

# Hardware Generated Nops (Bubble and Stalling)

Can we have the hardware automatically generates a nop?

- Why is it good for the hardware to do so anyways?

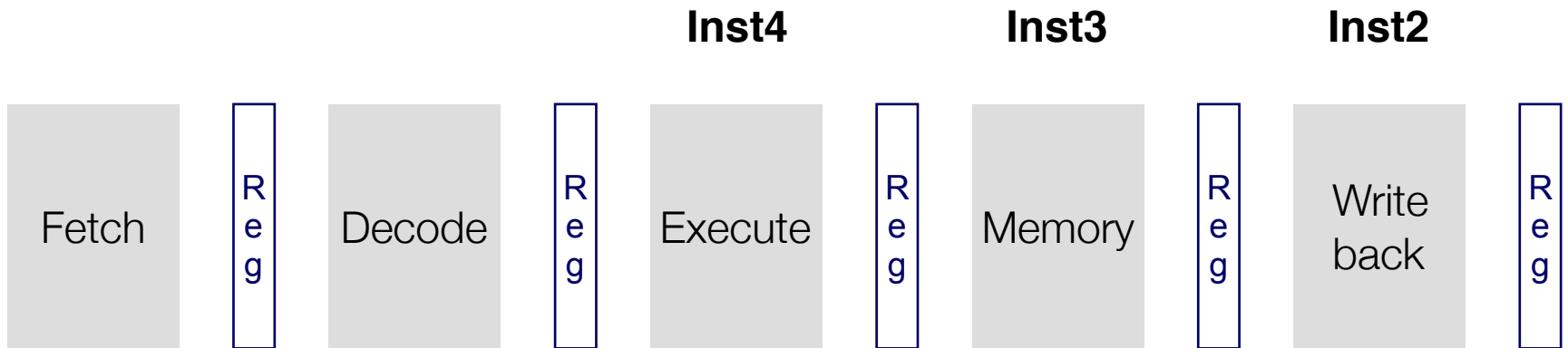

# How are Stall and Bubble Implemented in Hardware?

# How are Stall and Bubble Implemented in Hardware?

**Normal**

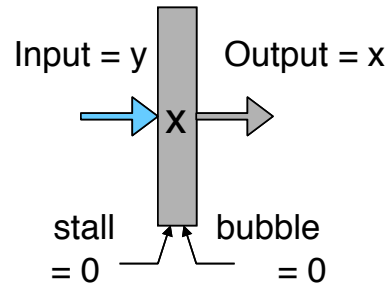

# How are Stall and Bubble Implemented in Hardware?

**Normal**

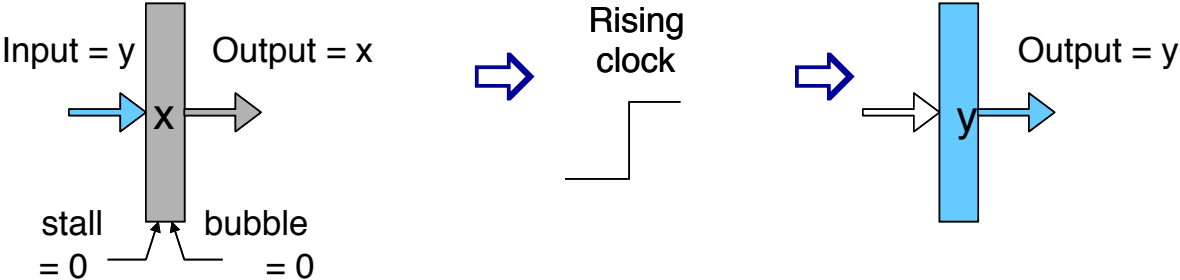

# How are Stall and Bubble Implemented in Hardware?

**Normal**

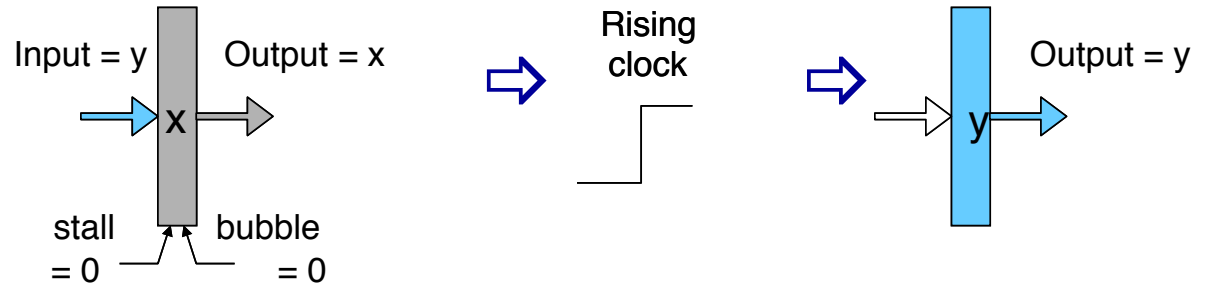

**Stall**

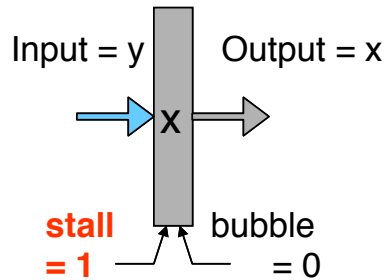

# How are Stall and Bubble Implemented in Hardware?

**Normal**

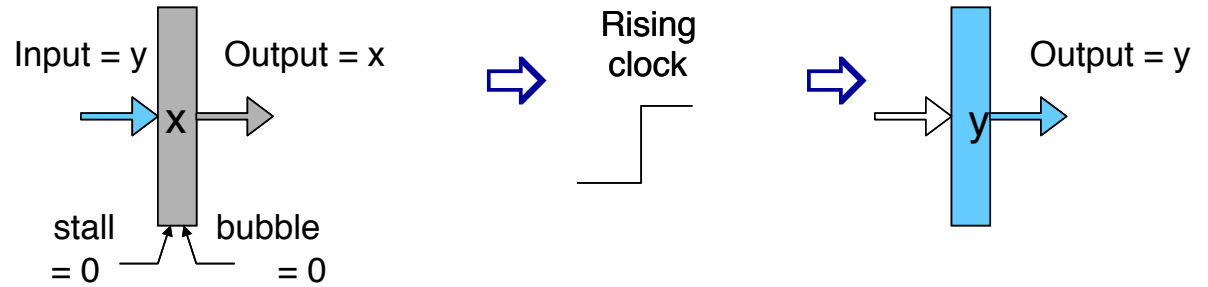

**Stall**

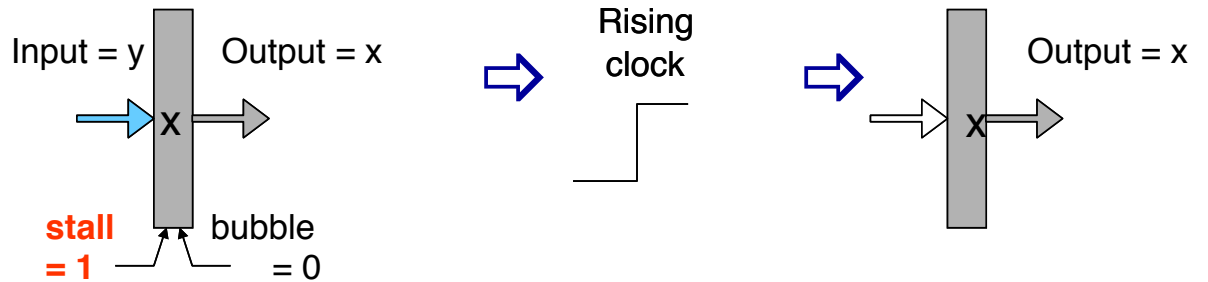

# How are Stall and Bubble Implemented in Hardware?

**Normal**

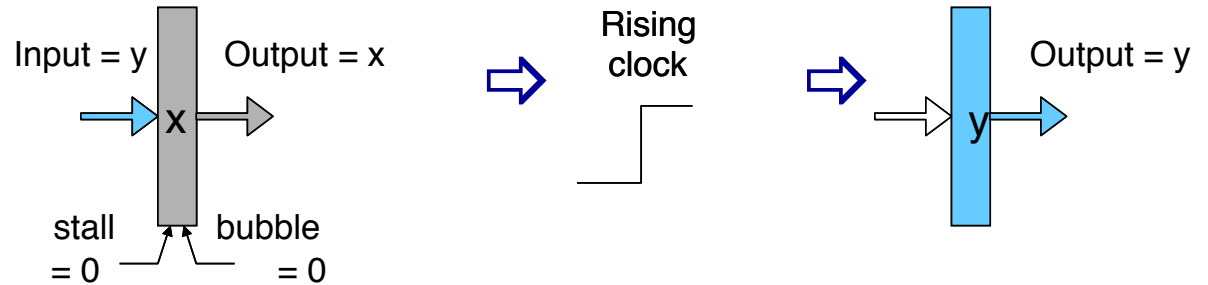

**Stall**

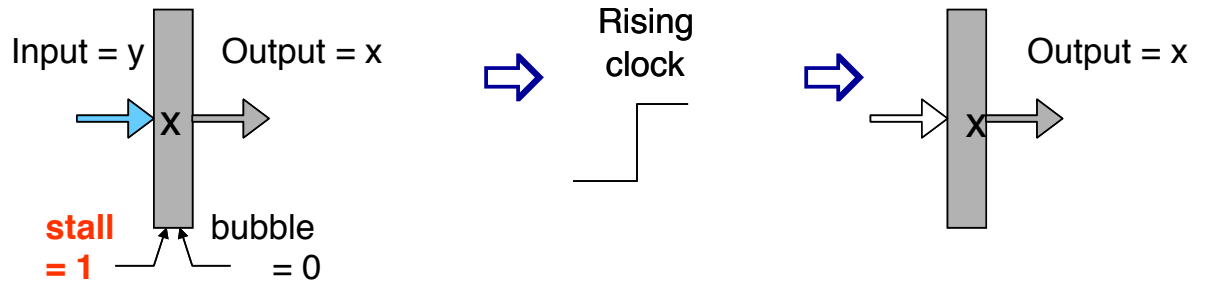

**Bubble**

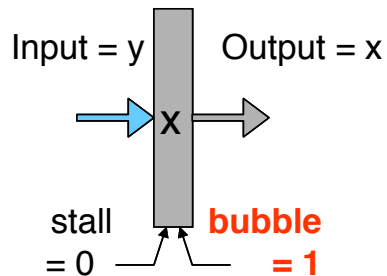



# How are Stall and Bubble Implemented in Hardware?

**Normal**

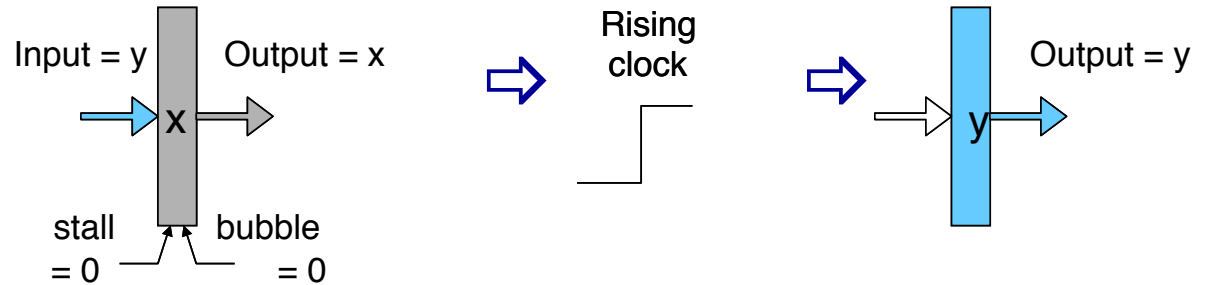

**Stall**

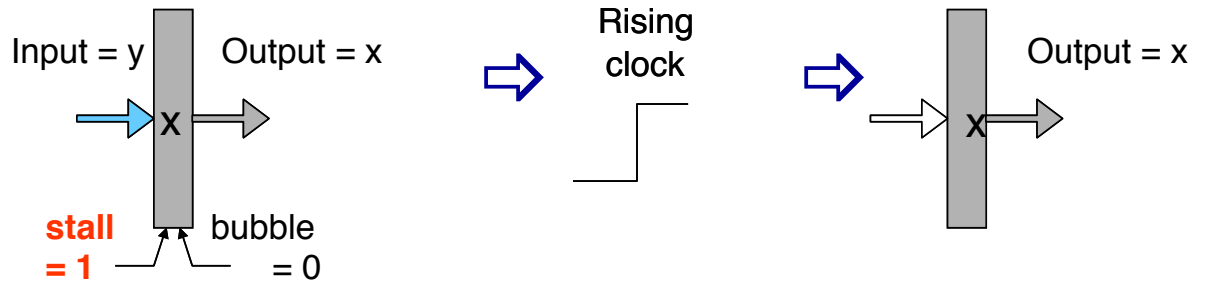

**Bubble**

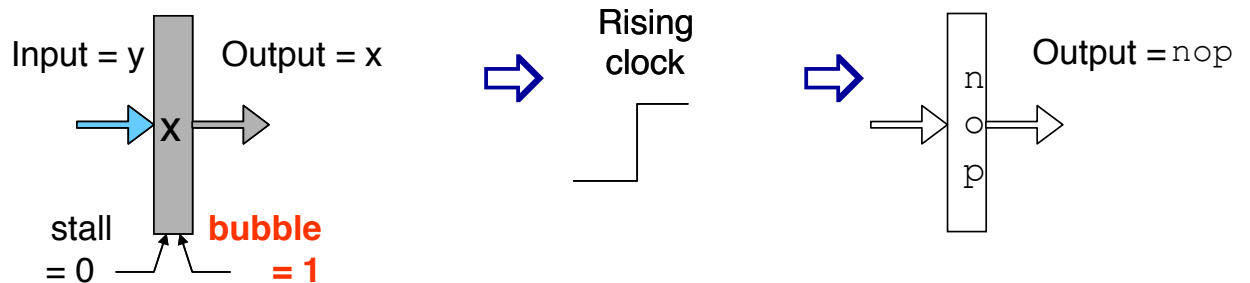

# Detecting Stall Condition

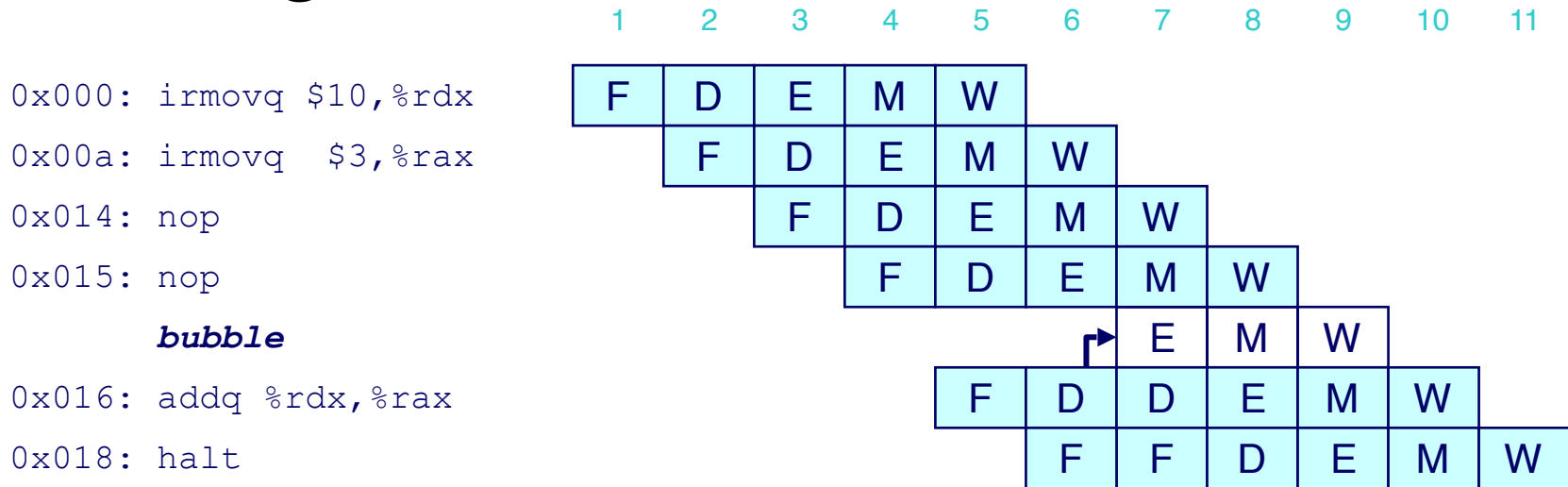

- Using a “**scoreboard**”. Each register has a bit.
- Every instruction that writes to a register sets the bit.
- Every instruction that reads a register would have to check the bit first.
  - If the bit is set, then generate a bubble
  - Otherwise, free to go!!

# Data Forwarding

## Naïve Pipeline

- Register isn't written until completion of write-back stage
- Source operands read from register file in decode stage
- The decode stage can't start until the write-back stage finishes

## Observation

- Value generated in execute or memory stage

## Trick

- Pass value directly from generating instruction to decode stage
- Needs to be available at end of decode stage

# Data Forwarding Example

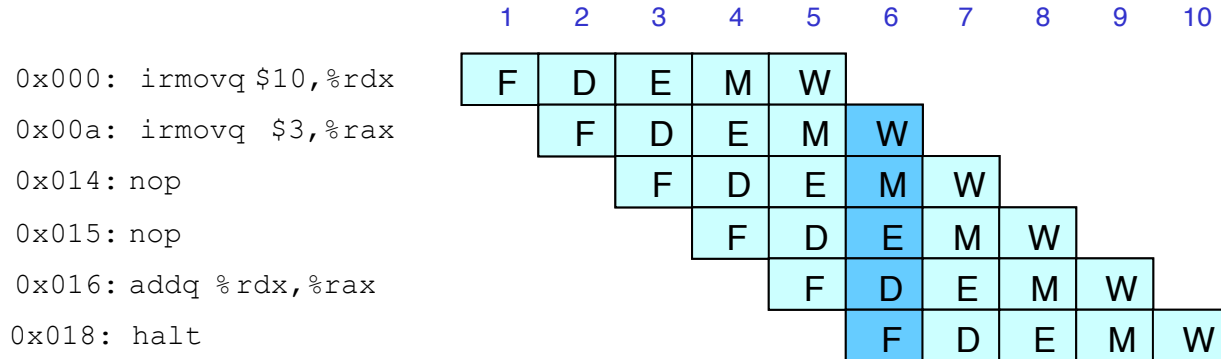

- `irmovq` writes `%rax` to the register file at the end of the write-back stage
- But the value of `%rax` is already available at the beginning of the write-back stage
- Forward `%rax` to the decode stage of `addq`.

# Data Forwarding Example

```
0x000: irmovq $10,%rdx
0x00a: irmovq $3,%rax
0x014: nop
0x015: nop
0x016: addq %rdx,%rax
0x018: halt
```

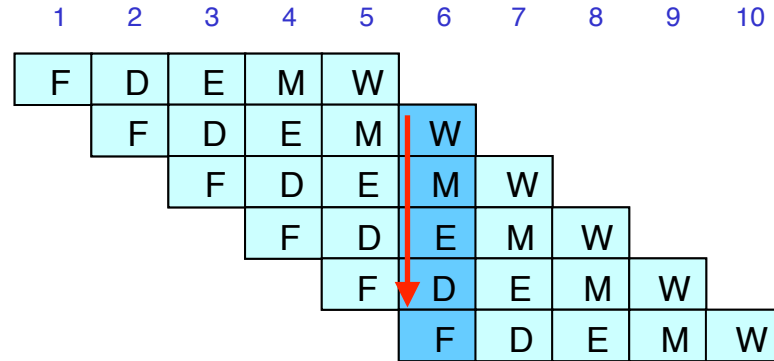

- `irmovq` writes `%rax` to the register file at the end of the write-back stage
- But the value of `%rax` is already available at the beginning of the write-back stage
- Forward `%rax` to the decode stage of `addq`.

# Data Forwarding Example #2

```
0x000: irmovq $10,%rdx
0x00a: irmovq $3,%rax
0x014: addq %rdx,%rax
0x016: halt
```

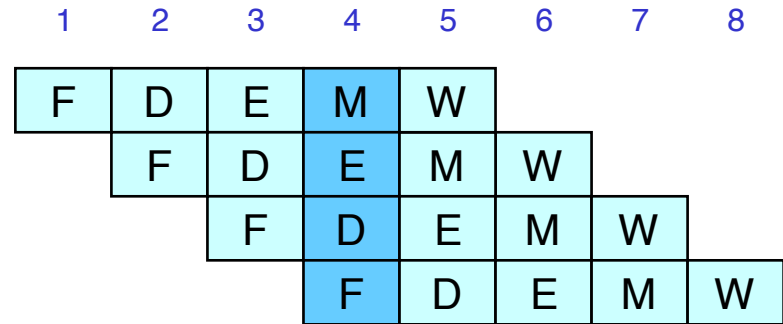

Register `%rdx`

- Forward from the memory stage

Register `%rax`

- Forward from the execute stage

# Data Forwarding Example #2

```
0x000: irmovq $10,%rdx
0x00a: irmovq $3,%rax
0x014: addq %rdx,%rax
0x016: halt
```

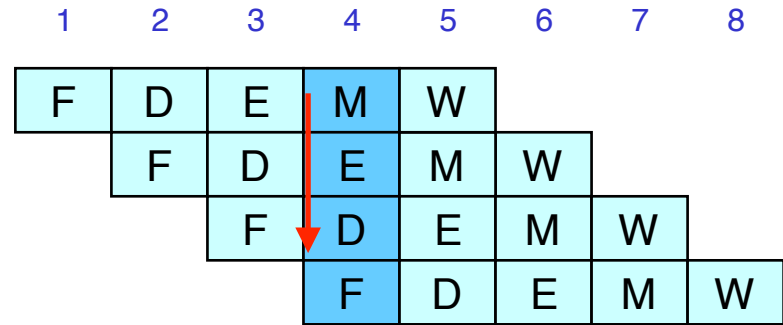

Register `%rdx`

- Forward from the memory stage

Register `%rax`

- Forward from the execute stage

# Data Forwarding Example #2

```
0x000: irmovq $10,%rdx
0x00a: irmovq $3,%rax
0x014: addq %rdx,%rax
0x016: halt
```

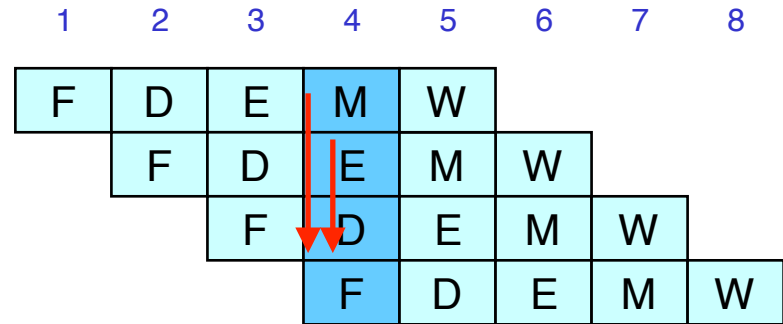

Register `%rdx`

- Forward from the memory stage

Register `%rax`

- Forward from the execute stage



# Out-of-order Execution

- Compiler could do this, but has limitations
- Generally done in hardware

Long-latency instruction.  
Forces the pipeline to stall.

```
r0 = r1 + r2  
r3 = MEM[r0]  
r4 = r3 + r6  
r7 = r5 + r1  
...
```



```
r0 = r1 + r2  
r3 = MEM[r0]  
r7 = r5 + r1  
...  
r4 = r3 + r6
```

# Out-of-order Execution

- Compiler could do this, but has limitations
- Generally done in hardware

Long-latency instruction.  
Forces the pipeline to stall.

```
r0 = r1 + r2
r3 = MEM[r0]
r4 = r3 + r6
r7 = r5 + r1
...
```

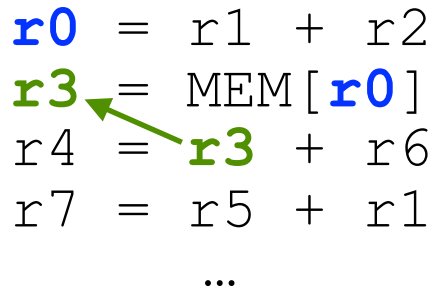

```
r0 = r1 + r2
r3 = MEM[r0]
r7 = r5 + r1
...
r4 = r3 + r6
```

# Out-of-order Execution

```
r0 = r1 + r2  
r3 = MEM[r0]  
r4 = r3 + r6  
r6 = r5 + r1  
...
```

# Out-of-order Execution

```
r0 = r1 + r2
r3 = MEM[r0]
r4 = r3 + r6
r6 = r5 + r1
...
```

Is this correct?



```
r0 = r1 + r2
r3 = MEM[r0]
r6 = r5 + r1
...
r4 = r3 + r6
```

# Out-of-order Execution

```
r0 = r1 + r2
r3 = MEM[r0]
r4 = r3 + r6
r6 = r5 + r1
...
```

Is this correct?



```
r0 = r1 + r2
r3 = MEM[r0]
r6 = r5 + r1
...
r4 = r3 + r6
```

```
r0 = r1 + r2
r3 = MEM[r0]
r4 = r3 + r6
r4 = r5 + r1
...
```

# Out-of-order Execution

```
r0 = r1 + r2
r3 = MEM[r0]
r4 = r3 + r6
r6 = r5 + r1
...
```

Is this correct?



```
r0 = r1 + r2
r3 = MEM[r0]
r6 = r5 + r1
...
r4 = r3 + r6
```

```
r0 = r1 + r2
r3 = MEM[r0]
r4 = r3 + r6
r4 = r5 + r1
...
```

Is this correct?



```
r0 = r1 + r2
r3 = MEM[r0]
r4 = r5 + r1
...
r4 = r3 + r6
```

# Out-of-order Execution

$r_0 = r_1 + r_2$   
 $r_3 = \text{MEM}[r_0]$   
 $r_4 = r_3 + \mathbf{r_6}$   
 $\mathbf{r_6} = r_5 + r_1$   
...

Is this correct?



$r_0 = r_1 + r_2$   
 $r_3 = \text{MEM}[r_0]$   
 $\mathbf{r_6} = r_5 + r_1$   
...  
 $r_4 = r_3 + \mathbf{r_6}$

$r_0 = r_1 + r_2$   
 $r_3 = \text{MEM}[r_0]$   
 $\mathbf{r_4} = r_3 + r_6$   
 $\mathbf{r_4} = r_5 + r_1$   
...

Is this correct?



$r_0 = r_1 + r_2$   
 $r_3 = \text{MEM}[r_0]$   
 $\mathbf{r_4} = r_5 + r_1$   
...  
 $\mathbf{r_4} = r_3 + r_6$

“**Tomasolu Algorithm**” is the algorithm that is most widely implemented in modern hardware to get out-of-order execution right.